

emco group

Designed for your profit



EMCO MAXXTURN 95

Universal CNC turning center for machining
shafts and chuck parts

TURNING
EMCO-WORLD.COM

EMCO MAX

1 CONTROL UNIT

- Ergonomic, swivel-type control panel
- Sinumerik 840D sl with 15" color monitor
- Comprehensive machining cycles
- 3D simulation
- USB interface, 230V power socket

2 WORK AREA

- Plenty of open space
- Perfect chip flow
- Easily accessible

3 MAIN SPINDLE

- 2 versions available
 - High-torque belt drive
 - Dynamic and rigid direct drive
- Max. speed range 2500 / 3500 rpm
- Spindle nose A2-8 (DIN 55026)
- Partly hollow draw-tube $\varnothing 95 \times 670$ mm
- Through hole $\varnothing 95$ mm optional

4 TOOL TURRET

- 12-position VDI 40
- 12 additional position on the outside with cooling connection (block-tool)
- Synchronized tapping and polygonal turning as standard



Machine with optional equipment



Tool turret disc
(Steel, 42CrMo4)



Drive shaft
(Steel, C45)

MAXXTURN 95

Maxxturn 95 is suitable for part lengths of up to 1300 mm and a turning diameter of 500 mm and can handle turning and milling operations involving heavy machining as perfectly as machining of precision parts with highest surface quality. A highly accurate C-axis, a rigid Y-axis with large movement path and high rapid traverses complete the performance package.



5 Y-AXIS

- Travel +80 / -60 mm
- 90° implemented in the machine construction
- Large distance between guides
- Stable and compact construction

6 CHIP CONVEYOR

- Hinged type chip conveyor with ejection height of 1150 mm (45.3")
- 350-liter coolant volume
- Included in the basic version

7 MACHINE COVER

- All-round protection against chips
- 100% coolant retention
- Large safety glass window in door
- Clear view into the work area

8 COMPACT MACHINE BUILD

- Requires minimal floor space



Wheel
(Aluminium)

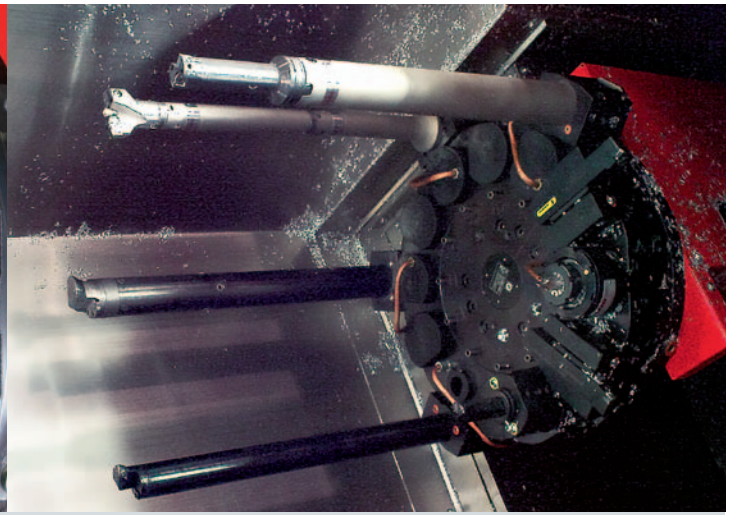
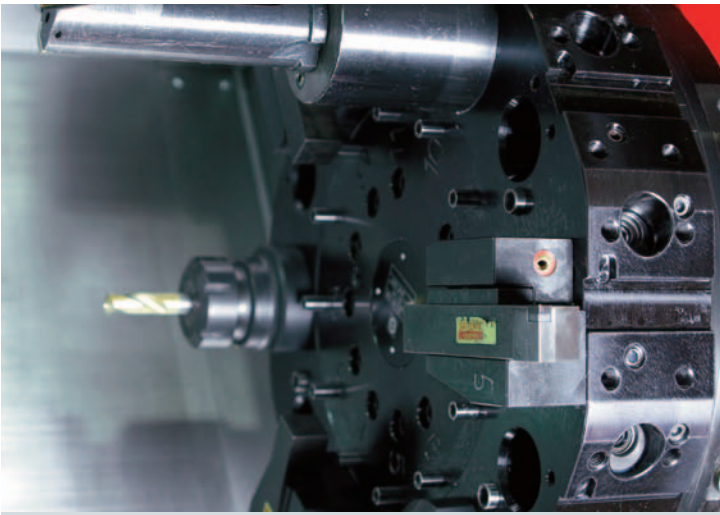

Tool turret: 12 + 12 station hybrid tool turret - VDI40 + block-tool, axial turret with single-motor technology. A servo motor powers the driven tools and the swivel movement. No tool rise, continuous switching with directional logic. Each station can take up driven tool holders with DIN 5480 coupling. 12 additional block-tool interfaces allow the use of large and heavy boring bars up to a diameter of 50 mm.

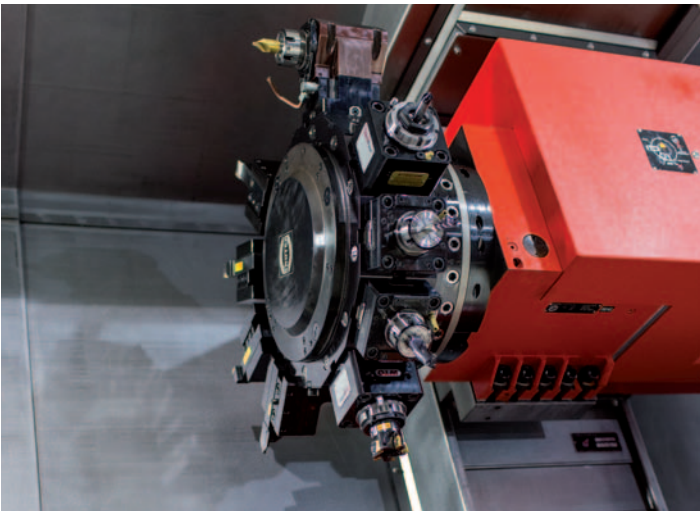

BMT turret. For cost-effective production of complex turning/milling work pieces, in which milling is predominant, the optional BMT 55P turret with water-cooled direct drive is available. With a maximum of 12000 rpm, 30 Nm and 10 kW, this turret offers optimum conditions, stability for complete machining and maximum productivity.

EMCO MAXXTURN 95 Technical

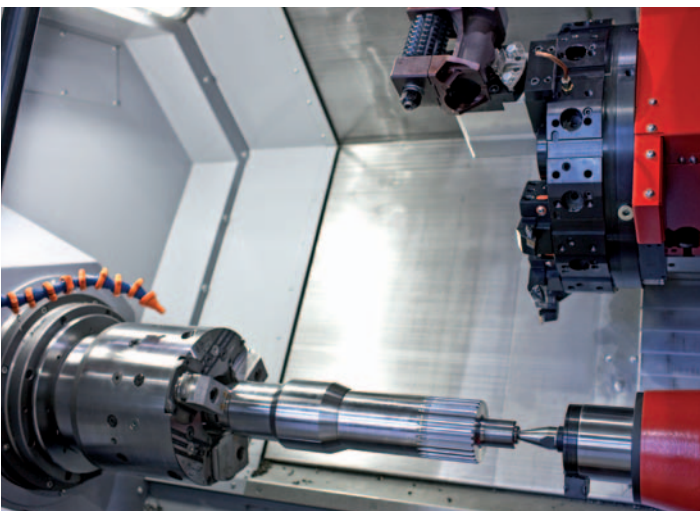

Main spindle. Two versions are available. One using a conventional beld-drive for high torque (up to 1040 Nm) and heavy machining and another one using the approved water-cooled motor spindle for higher spindle speeds. This one also offers optimal conditions for complex milling operations.

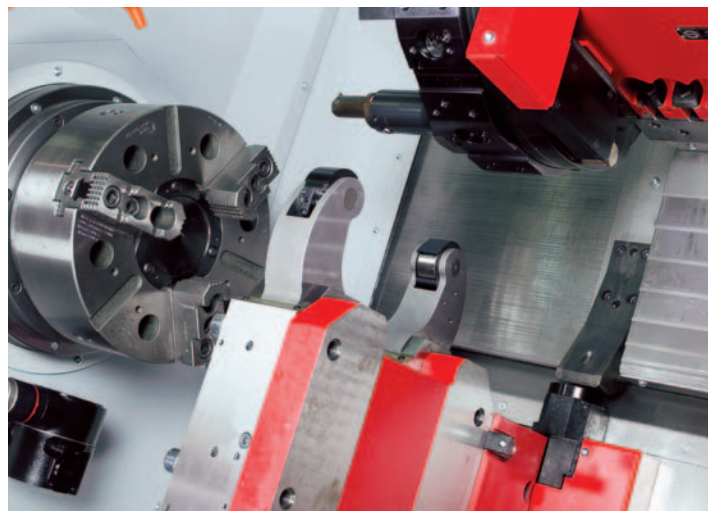

Steady-rest. The hydraulic operated self-centering steady-rest has a clamping range of $\varnothing 30 - 245$ mm. It is mounted on a slide, which can be positioned via the Z-axis-slide or optionally via an additional servo drive using a ball screw. At the determined position the slide is hydraulically clamped. The steady-rest includes chip protection and central oil lubrication.

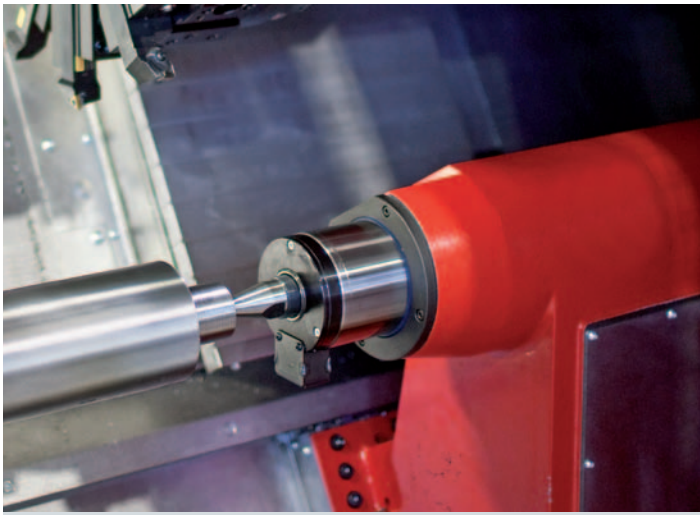

Tailstock. The tailstock is mounted on linear roller-type slides and can be positioned via the z-axis-slide. Optionally an additional servo drive using a ball screw can be offered. At the determined position the slide is hydraulically clamped. So that a quill with integrated bearings and MT4 cone can support the workpiece. Therefore the quill can move up to 120 mm.

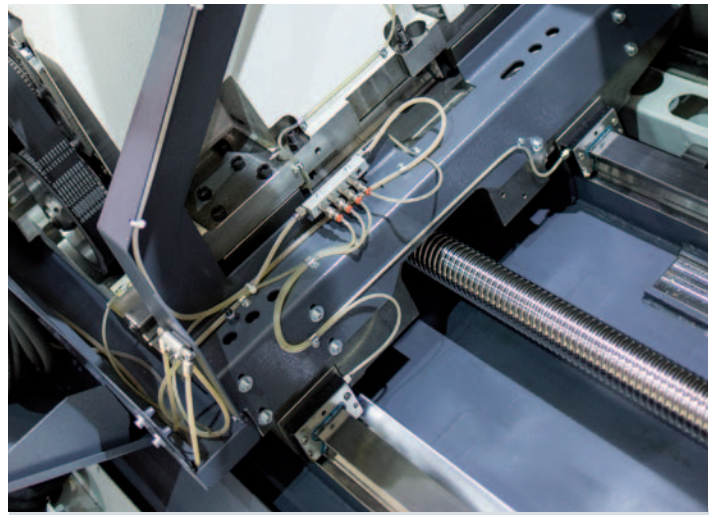

Y-axis. The Y-axis forms a highlight in the MAXXTURN series. She is integrated in the machine structure so that maximum stability based on short overhangs and wide distanced roller guides is guaranteed. Thus, complex machining tasks can be done and workpieces can be completely finished in a single setup.

Highlights

Highlights

- Extremely robust construction
- Top machining precision
- High rapid motion speed
- Stable Y-axis with large travel
- Optional: NC steady rest or tailstock
- State-of-the-art control technology
- Driven tools with C-axis
- Simple, conversational programming
- Made in the Heart of Europe

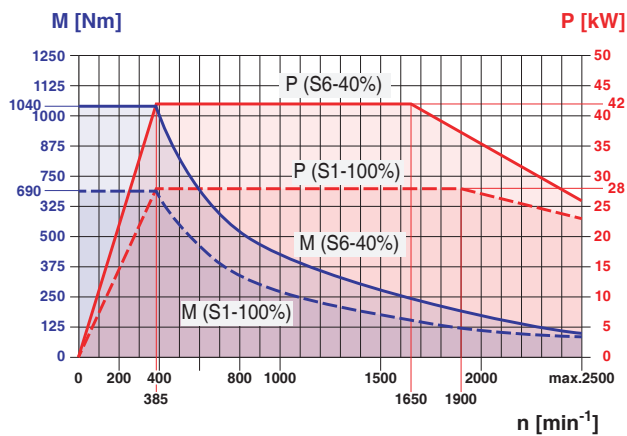

Performance and torque curve for main spindle with belt-drive

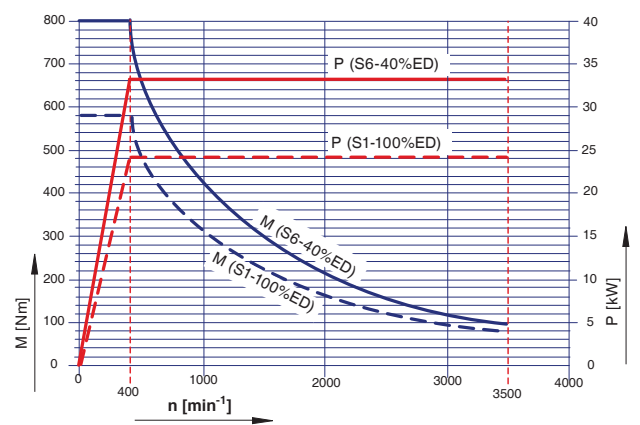

Performance and torque curve for main spindle with direct drive

EMCO MAX

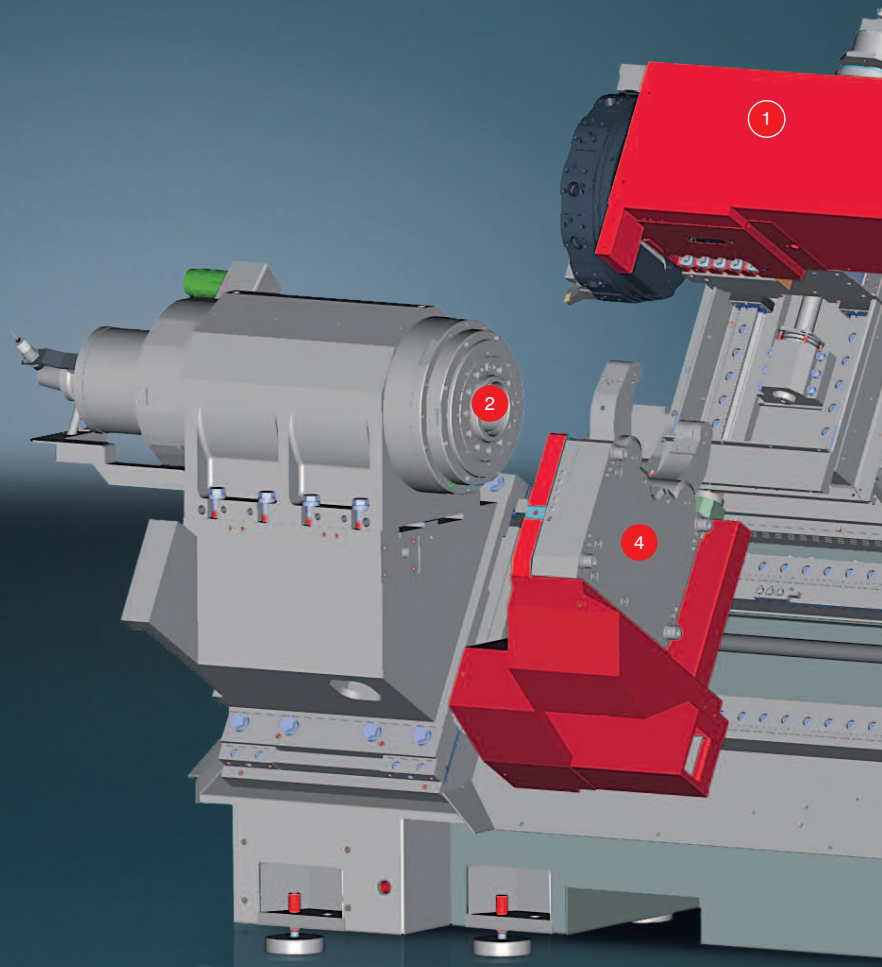

1 TOOL TURRET

- VDI quick-change system
- 12 driven tool stations
- Additional Block-Tool mounting surfaces to hold long boring bars
- Adjustable swivelling speed

2 MAIN SPINDLE

- High drive performance 42 / 33 kW
- Large holding torque for milling
- Closed-circuit cooling system
- A2-8 spindle nose
- Partly hollow draw-tube $\varnothing 95 \times 670$ mm
- Hollow clamping cylinder $\varnothing 95$ mm (optional)

3 ROLLER GUIDES

- In all linear axes
- Preloaded
- No backlash in any direction of force
- High rapid-motion speeds
- No wear
- Minimal lubrication required

MAXXTURN 95

Designed on the basis of FEM analyses, the MAXXTURN 95 meets the high demands of modern machining in an ideal manner. The machine's core element is the one-piece machine bed. It is designed as a closed welded steel construction and filled with HYDROPOL®. Additional reinforcements ensure maximum stability in the more highly stressed areas. This guarantees maximum stiffness, precision and optimum vibration damping. The MAXXTURN 95 stands for high durability teamed with high processing accuracy. It is the basis for production with a high added value.

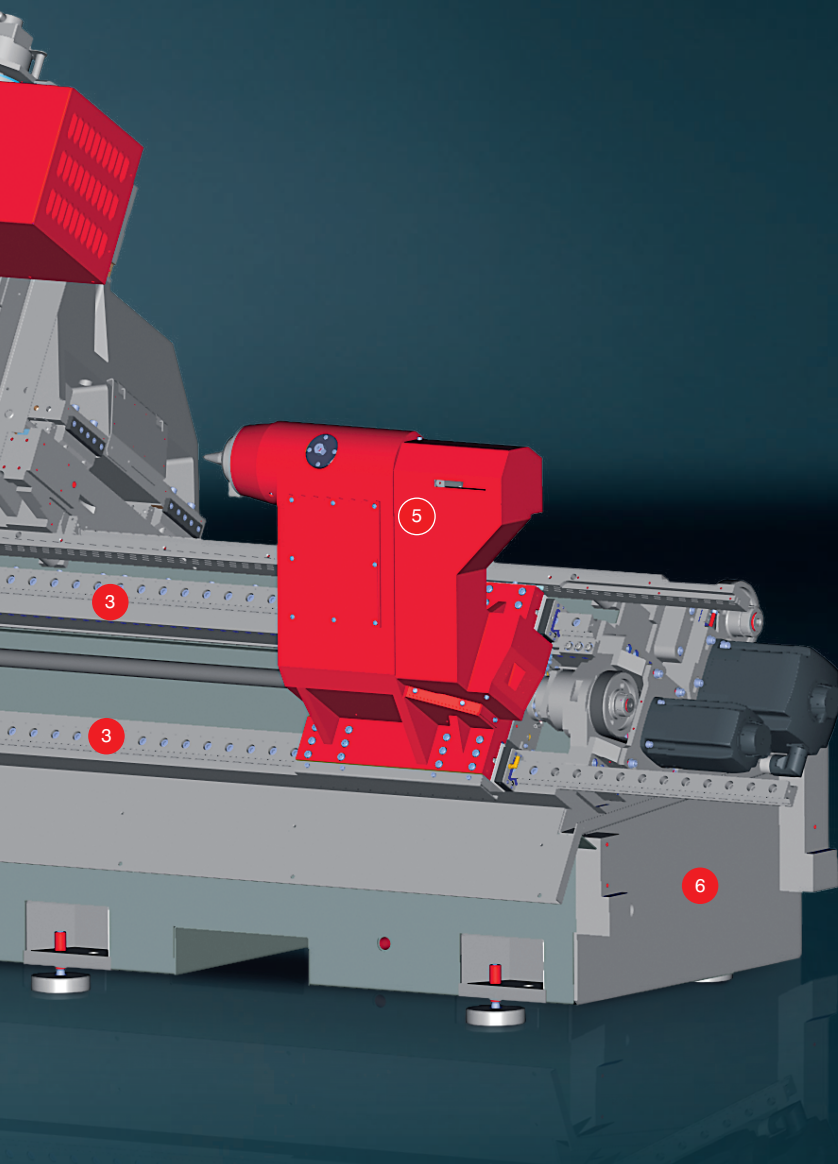

4 STEADY REST

- Clamping range \varnothing 30 – 245 mm
- Self-centering
- Centrally lubricated with pressurized sealing air
- Tag-along positioning or NC controlled

5 TAILSTOCK

- 1050 mm travel range (915 mm with steady-rest)
- \varnothing 100 mm quill diameter
- 120 mm quill stroke
- MT4 inside taper
- Tag-along positioning or NC controlled

6 MACHINE BASE

- Monoblock construction
- Welded steel design filled with HYDROPOL®

Everything from

1 GANTRY AXES

- Robust mechanism
- Safety brake
- Central lubrication system
- Optional: H-loader, machine connection

2 BLANK CONVEYOR / FINISHED PARTS CONVEYOR

- Shaft conveyor (shown)
- Circulating magazine

3 GANTRY

- Electric shaft gripper
- Adjustable gripping force
- Position monitoring via NC axis
- No compressed air required

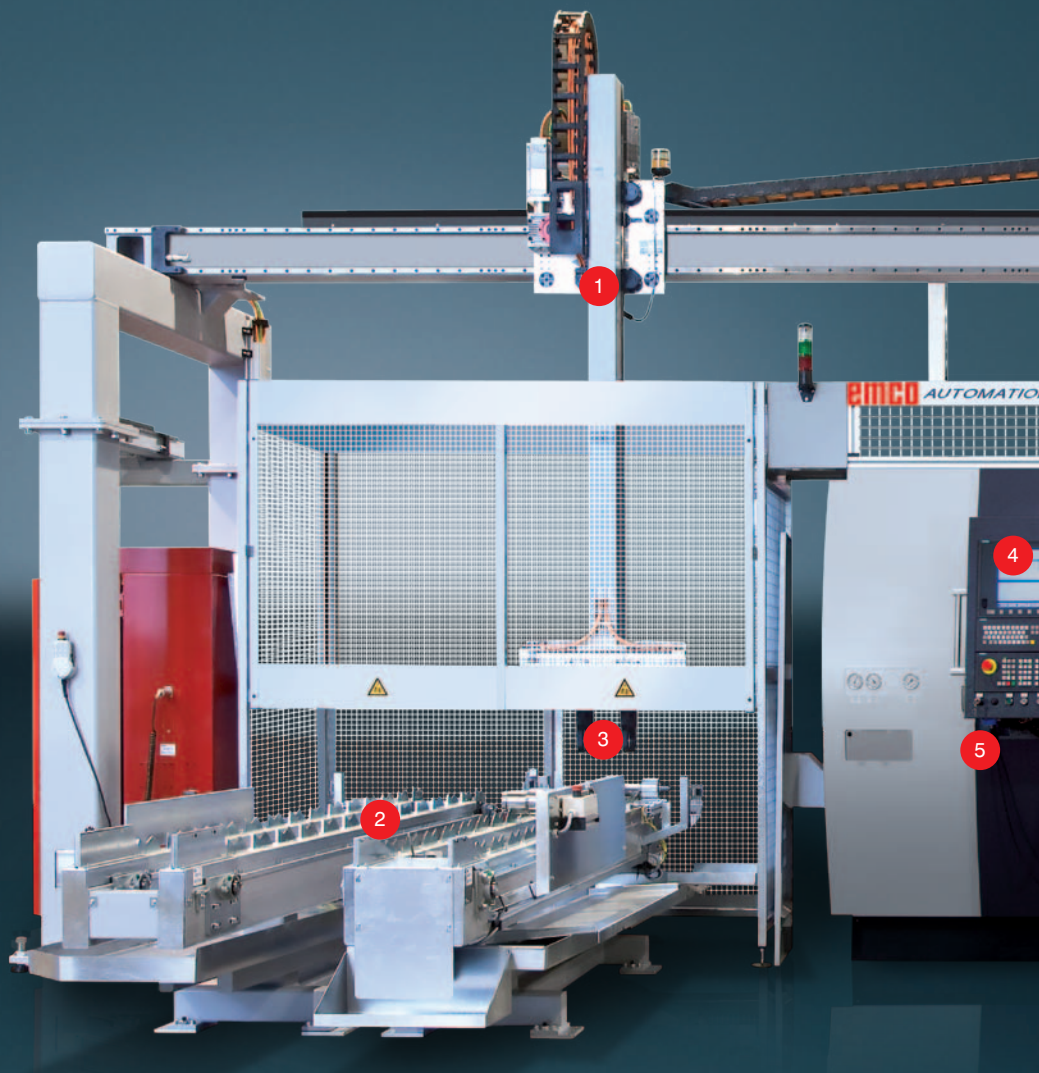

Magazine: Raw materials and finished parts are automatically supplied and discharged by dual-track indexed conveyor. The conveyor was designed for a capacity of 20 parts. The shaft gripper seizes the raw workpiece, which is centred on both sides, from the indexed conveyor and brings it into the machine. Magazing of raw materials and finished parts is carried out in the same way. The loading gantry is designed for a maximum workpiece weight of 150 kg.

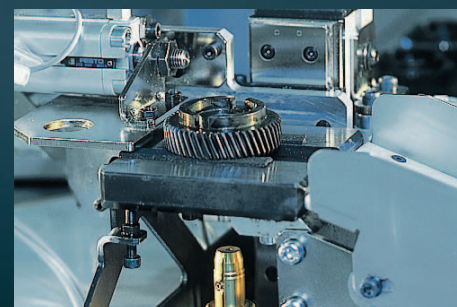

a single source.

The EMCO loading gantry solution provides maximum flexibility in terms of weight and machine size. It allows the integration of various automated systems such as a shaft conveyor, circulating magazine, robot, or measurement station. This enables various combinations of minimally staffed complete solutions to be implemented in line with customer requirements.

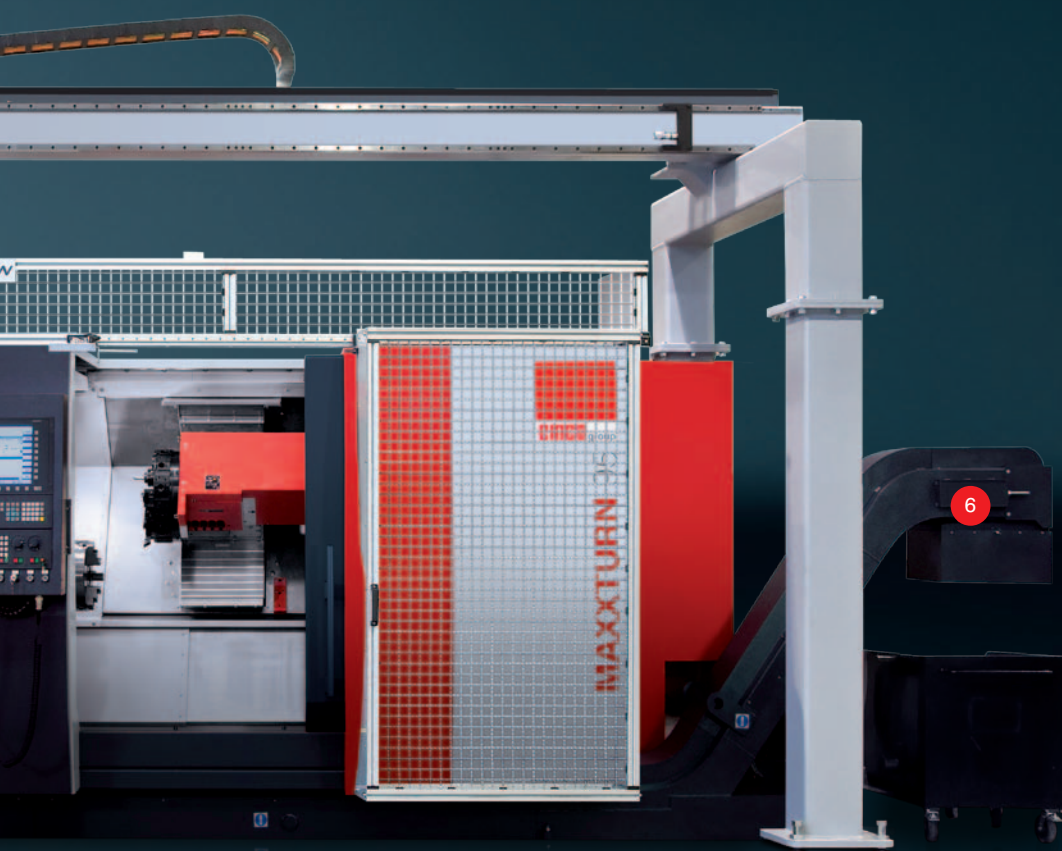

4 CONTROL

- Ergonomically placed and pivotable
- Multi-channel for machining and parts handling
- Siemens 840D sl incl. ShopTurn
- Color LCD monitor
- USB interface
- Ethernet connection

5 HYDRAULIC UNIT

- Ergonomic operation
- Automatic pressure monitoring
- Compact and low-maintenance

6 CHIP CONVEYOR

- Hinged-type conveyor
- Ejection height 1150 mm (45.3")
- 350-liter coolant volume
- Included in the basic model

Measuring device: Measuring station integrated at the machining table for machining of precision parts with minimum manpower. The tool offsets are adjusted automatically. By means of the gantry loader, each workpiece is placed into the measuring device and measured with the measuring gauge. Good parts are pushed into the parts container, rejected parts are stored separately.



Operation: The Maxxturin 95 gantry loaders were designed by EMCO and are electrically and NC-technically controlled and programmed via the machine control. For this purpose, an additional, independent handling program runs at the control. The shaft grippers are actuated by a self-locking threaded spindle and are easily adjustable to the respective workpiece. The handheld terminal provides for an easy and clear operation of individual machine components and is integrated into the machine.

Quality Components

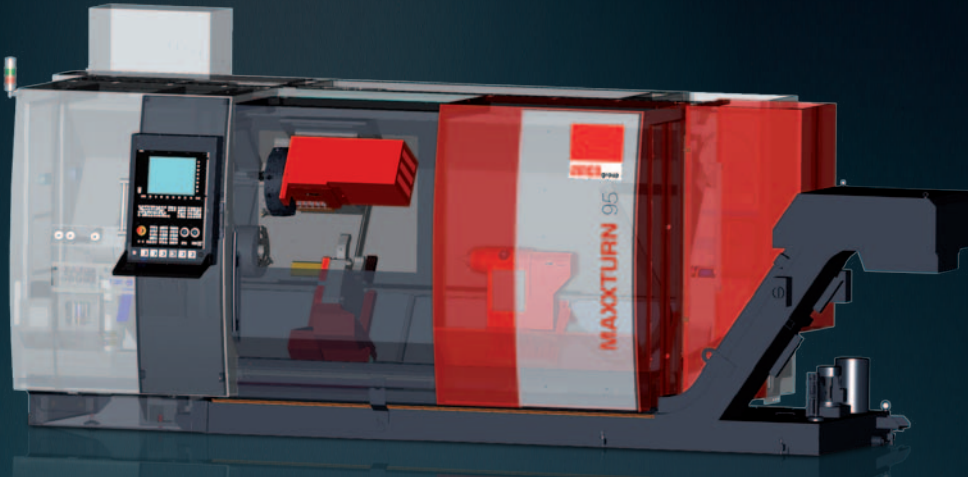

Coolant pumps

Low-maintenance immersion pumps for pressures of up to 25 bar and flow rates of up to 1500 l/min provide optimum conditions for machining and enable reliable chip transportation.



Clamping cylinder / chuck

Hydraulically activated clamping cylinders and chucks guarantee the precise, safe clamping of work pieces. Programmable sensors are used for stroke monitoring. There is no need for time-consuming adjustments of contactless limit switches.



Tool holder

Innovative, fully developed tool holder systems form the basis for cost-effective machining. High changeover accuracy and stability result in short setup and cycle times.



Headstocks

The design and manufacture of headstocks are two of EMCO's core competencies. During engineering, the focus is on precision, robustness, high rigidity, precise rotational characteristics, and a long service life.



Hydraulic systems

Compact dimensions, quiet operation, and high energy efficiency - just some of the advantages of the hydraulic assemblies used by EMCO. Monitored pressure switches prevent the need for time-consuming manual pressure adjustments.

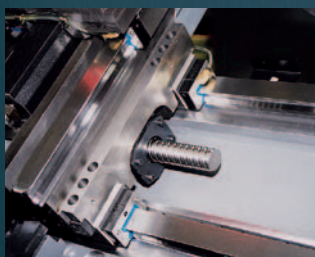

Machine bases and slides

When matching components, we place great value on high stability, good damping characteristics, and a thermoneutral design. We achieve high stability through a shorter force flow, thermal stability through symmetry, and dampening through the materials and interfaces selected.

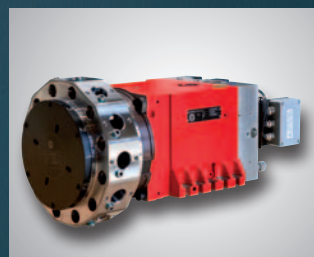

Tool turret

Rapid-indexing turrets with adjustable swivel speeds and milling drives represent the current state of the art. The backlash-free milling drive is not only ideal for milling and drilling, but also for rigid tapping, hobbing, and polygonal turning.

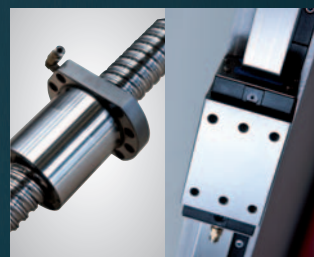

Ball screws and roller guides

Highly precise and generously dimensioned guide rails and ball screws with optimal pretensioning form the basis for the machining of precision parts



Chip conveyor

Slat band conveyors allow for flexible implementation and the safe removal of chips. A monitored overload clutch prevents damage from improper use.

Minimum use of resources for maximum profit.



At EMCO, we take a consistent, responsible approach to the use of resources in machine tools in order to safeguard long-term investments. From the development of our machines through to their construction and manufacture, we place a strong focus on the sensible and sparing use of raw materials and energy. This enables us to achieve parallel savings in two areas:

1. Reduction in the basic power consumption of machine tools, e.g. assemblies are switched on and off as required and the installed connected loads are kept to a minimum.
2. Reduction in variable consumption: This can be seen in the lighter axes, energy recovery system, increased rate of good parts, and the shorter process chain enabled by complete machining.

Through these measures, which are constantly being refined and further optimized, EMCO truly demonstrates that its slogan of „Designed for your Profit“ is not just an empty promise: EMCO products help save the environment and provide intelligent customer savings without compromising on quality and flexibility.

[Regenerative drive system]

Kinetic energy is converted into electrical energy and fed back into the grid.
Savings of up to 10%

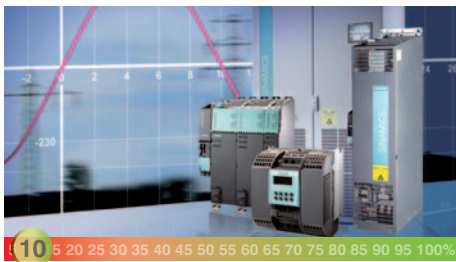

[Compact hydraulics unit with pressure accumulator]

Thanks to its accumulator charging system, the pump only runs when required. If the pressure accumulator is full, the pump switches over to closed loop circulation.
Savings of up to 90%



[Roller guides]

Extremely low friction losses thanks to rolling friction. Highly dynamic performance with minimal lubricant consumption.
Savings of up to 50%



[Structurally optimized mechanics]

FEM analysis is used to optimize the relevant components in terms of their rigidity while simultaneously reducing their weight.
Savings of up to 10%

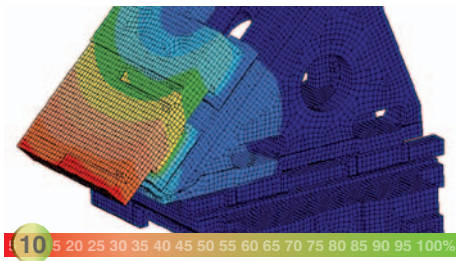

[Highly efficient motors]

The use of energy-efficient motors (IE2) in the coolant preparation area guarantee highly cost-effective operation.
Savings of up to 10%



[Synchronized chip conveyor]

Programmable interval times enable optimal use of the chip conveyor independently of the machining process.
Savings of up to 95%

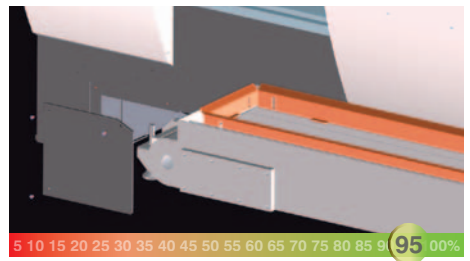

[Intelligent standby concepts]

Reduced consumption by automatically switching off ancillary units and machine space/screen illumination after a defined period of inactivity on the control panel.
Savings of up to 50%



[Virtual machine]

Significant reduction in the setup and running-in times on the machine through the use of highly developed simulation and programming software.
Savings of up to 85%

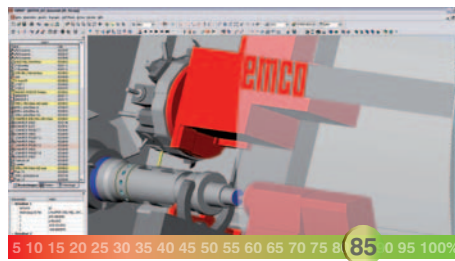

[Intelligent energy management]

Intuitive data entry screens for activating the individual energy-saving functions.
Savings of up to 70%

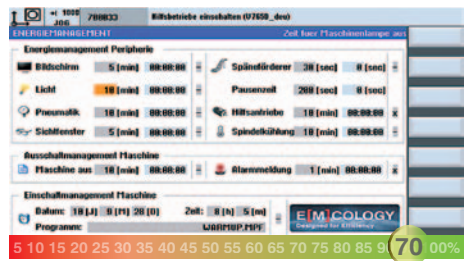



DASHBOARD – For a Quick Overview of the Machine Status

Clear and compact processing of all relevant machine and NC data depending on the configuration of the machine (number of tool systems, spindles, ...) and the active operating mode (JOG, MDA, AUTO). Know at a glance whether everything is OK or whether the machine operator will be required to interact.



emcoCONNECT's hardware basis is a 22" industrial touch control panel combined with an industrial PC (IPC).

Highlights

- Direct interaction between EMCO Apps and the control
- Intuitive user interface optimized for touch control
- Range of available applications is continuously being expanded
- Customised and project-specific applications
- Optimized for the EMCO machine range
- emcoCONNECT allows for easy and quick configuration and updating

er“ for fire production flow

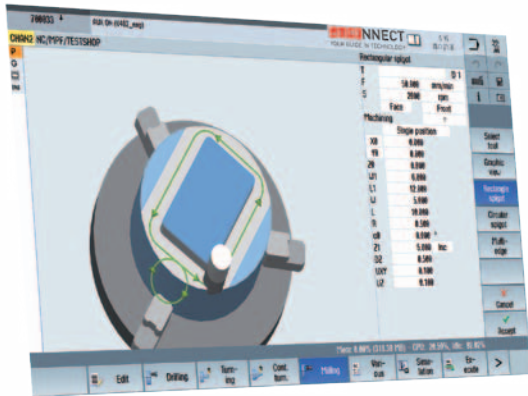

SINUMERIK - the Control and the Machine's Centerpiece

Thanks to the App Launcher operators may switch between the emcoCONNECT Apps and the control at any time. All it takes to do so is a click on the emcoCONNECT logo. To improve the work processes on the machine the control can, as shown in the picture, be operated in full screen mode or in interaction with practical apps (sidebar).

MACHINE DATA – All Data related to Productivity at a Glance

Operating data collection to inform the user about the current production status and OEE (Overall Equipment Effectiveness) values full screen or sidebar.



DOCUMENTS – A Digital and Expandable Document Collection Customised to Suit Your Individual Needs

To display PDF documents such as machine documentations, programming instructions, process descriptions ... Including favourites management - full screen or sidebar

Installation plan

Machine layout

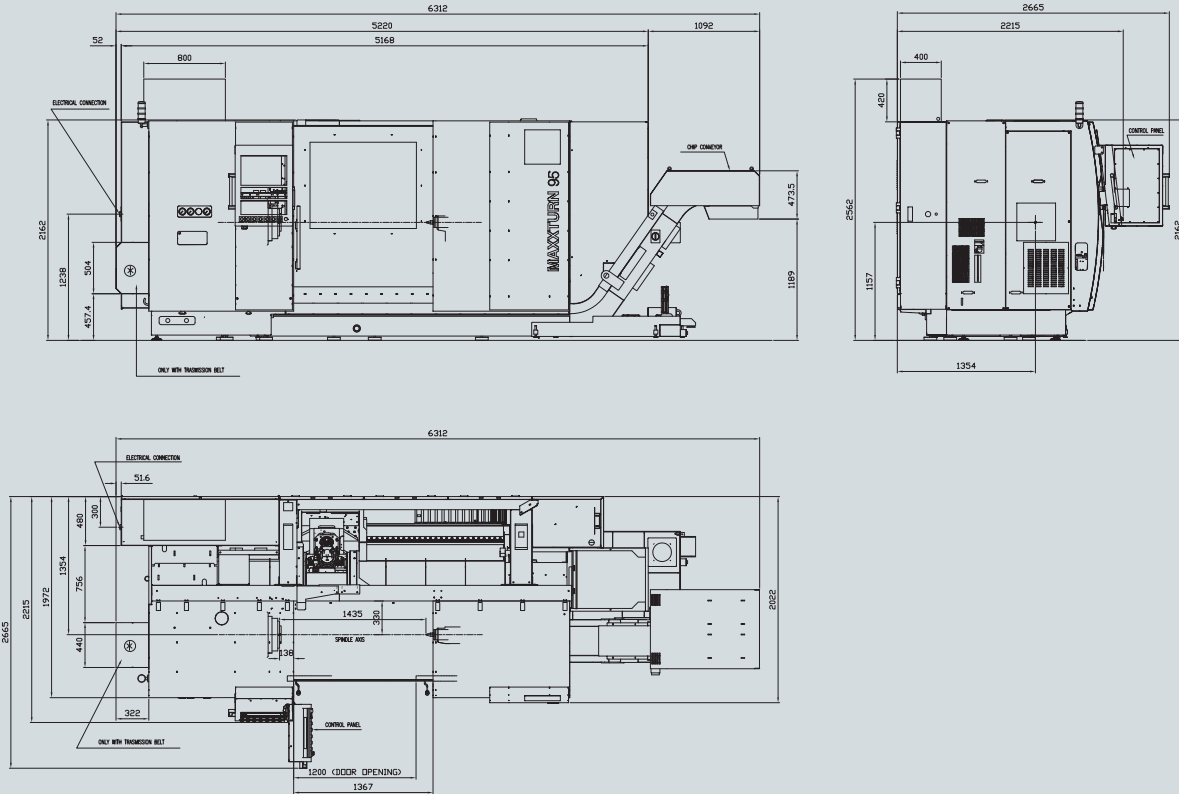

Machine layout MAXXTURN 95 with gantry loader

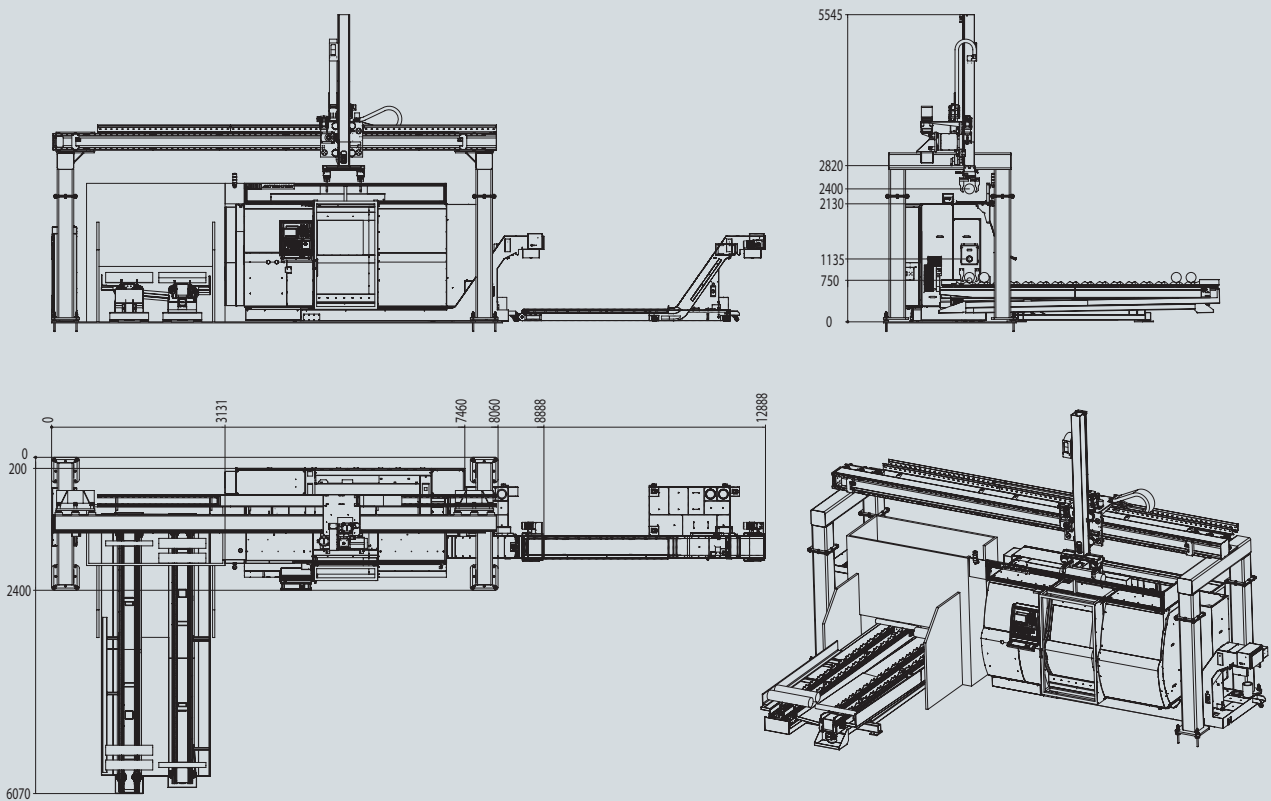

Details in millimeters

Emco MAXXTURN 95

Technical Data

Work area

Swing over bed	700 mm (27.6")
Swing over cross silde	500 mm (19.7")
Distance between centers	1430 mm (56.3")
Max. turning diameter	500 mm (19.7")
Max. part length	1300 mm (51.2")
Draw tube bore	95 mm (3.7")

Travel

Travel in X	318 mm (12.5")
Travel in Z	1360 mm (53.5")
Travel in Y	-60 / +80 mm (-2.4 / +3.1")

Main spindle

Spindle nose DIN 55026	A2-8
Speed range for belt drive	0 – 2500 rpm
Max. drive performance	42 kW (56.3 hp)
Max. torque on the spindle	1040 Nm (767 ft/lbs)
Speed range for direct drive	0 – 3500 rpm
Max. drive performance	33 kW (44.2 hp)
Max. torque on the spindle	800 Nm (589.6 ft/lbs)

C-axis

Round axis resolution	0,001°
Rapid motion speed	1000 rpm

Tailstock with quill

Tailstock travel	1050 mm (41.3")
Max. application force	12500 N (2810 lbs)
Max. traverse speed	4 m/min (157.5 ipm)
Tool holding shaft (with integrated bearings)	MT4

Tool turret

A number of tool positions	12 + 12
Tool holding shaft in accordance with VDI (DIN 69880)	40 mm (1.6")
Tool cross-section for square tools	25 x 25 mm (1 x 1")
Shank diameter for boring bars	40 mm (1.6")
Turret indexing time	0.4 sec

Driven tools

Number of tool positions	12
Max. speed	0 – 4000 rpm
Max. torque	45 Nm (33.1 ft/lbs)
Max. drive performance	8 kW (10.7 hp)

Tool turret with BMT-interface and direct drive system

Number of tool positions	12
Precision tool holder interface	BMT-55P
Tool cross-section for square tools	20 x 20 (25 x 25) mm 0.79 x 0.79" (1 x 1")
Shank diameter for boring bars	40 mm (1.6")
Turret indexing time	0,5 sec
Max. speed for driven tools	0 – 12000 rpm
Max. torque for driven tools	30 Nm (22.13 ft/lbs)
Max. drive performance for driven tools	10 kW (13.4 hp)

Feed drive

Rapid motion speed X / Z / Y	24 / 30 / 12 m/min (944.9 / 1181.1 / 472.4 ipm)
Feed force in the X axis	9000 N (2023.2 lbs)
Feed force in the Z axis	13000 N (2922.4 lbs)
Feed force in the Y axis	9000 N (2023.2 lbs)
Acceleration time from 0 to rapid motion	0.2 sec

Coolant system

Tank volume	350 liters (92.6 gal)
Pump performance	1.15 kW (1.5 hp)

Dimensions

Height of centers above floor	1135 mm (44.5")
Machine height	2162 mm (85.1")
Required space for machine W x D	6300 x 2240 mm (248 x 88.1")
Total weight approx.	10500 kg (23148.5 lb)

GANTRY LOADER

Technical Data

Traverse speed horizontal	80 m/min (3150 ipm)
Traverse speed vertical	40 m/min (1575 ipm)

Application example: Maxxturn 95

Workpiece dimensions for	flanged / shaft parts
Max. diameter	250 / 180 mm (9.8 / 7.1")
Max. length	100 / 800 mm (3.9 / 31.5")
Max. weight	25 / 150 kg (55.1 / 330.7 lb)