

emcogroup

Designed for your profit



HYPERTURN 45

High-performance universal turning
center for complete machining

TURNING
EMCO-WORLD.COM

HYPERTURN 45

1 UPPER TOOL TURRET

- 12-station tool turret
- VDI25 quick-change system
- 12 driven tool stations
- Servo-controlled
- Rigid tapping
- Polygonal turning, etc.

2 MAIN SPINDLE

- Integrated, water-cooled spindle motor (ISM)
- High drive power: 15 kW
- High torque: 100 Nm
- Wide speed range: 0-7000 rpm
- Extremely dynamic
- Bar capacity \varnothing 45 (51) mm

3 COMPACT MACHINE DESIGN

- Minimal floor space

4 LOWER TOOL TURRET

- 12-station tool turret
- VDI25 quick-change system
- 12 driven tool stations
- Servo-controlled
- Rigid tapping
- Polygonal turning, etc.



Machine with optional equipment



Starter pinion
(42 Cr Mo 4)



Hip joint cup
(Titanium alloy)

The new Hyperturn 45 is characterized by its dynamics and great flexibility. With two high-performance spindles, two tool turrets and a Y-axis, it is designed to handle challenging production requirements with ease. Its compact dimensions and high static and dynamic rigidity provide the best possible conditions for manufacturing medium to large quantities of precision workpieces. It is particularly suited to use in general machinery and equipment engineering and also in the high-precision areas of medical technology and the jewelry industry.

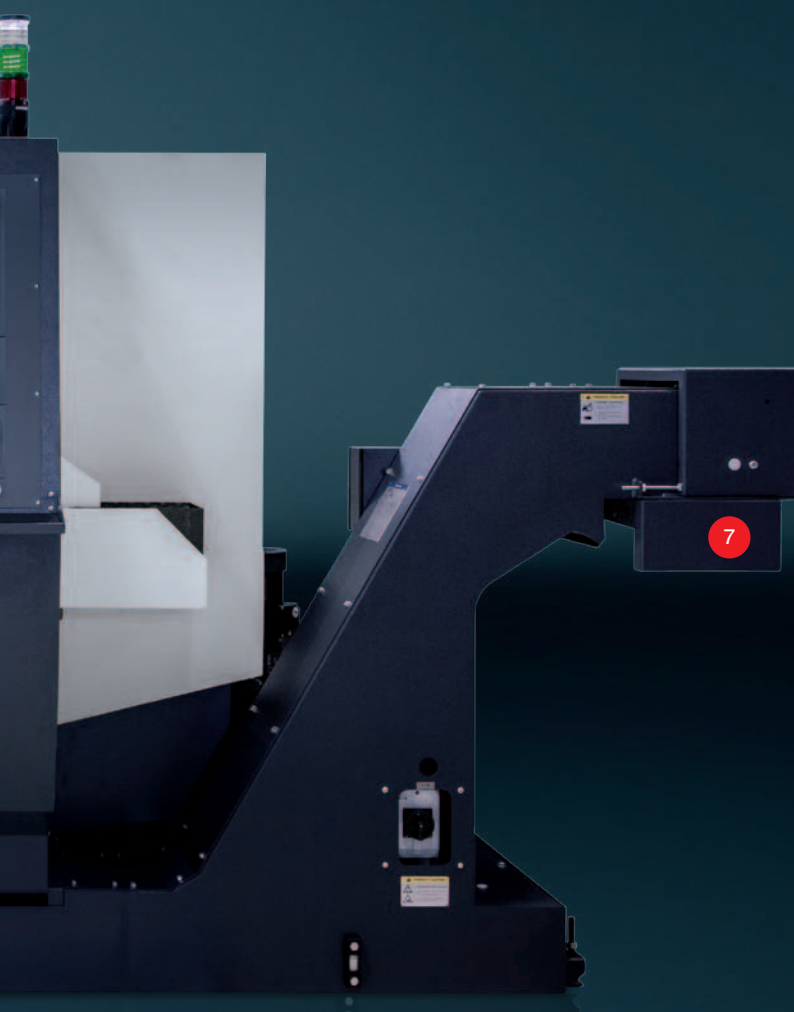

5 Y-AXIS

- Travel +40 / -30 mm
- 90° implemented in the machine construction
- Large distance between guides
- Stable and compact construction

6 CONTROL UNIT

- Ergonomically designed
- Siemens Sinumerik 840 D sl or Fanuc 31i-B
- LCD color monitor 15"

7 CHIP CONVEYOR

- Slant-bed conveyor belt
- Ejection height 1200 mm
- Integrated coolant tank 200 l
- Turret pumps: 2 x 14 bar
- Flushing pumps: 2 x 3.7 bar

8 COUNTER SPINDLE

- Integrated, water-cooled spindle motor (ISM)
- High drive power 15 kW
- High torque: 100 Nm
- Wide speed range: 0 – 7000 rpm
- Highly dynamic
- Bar capacity \varnothing 45 mm (optional)



Dental contra-angle handpiece
(Brass)



Plug
(Steel)

Structure

1 ROLLER GUIDES

- In all linear axes
- Preloaded and backlash-free
- High rapid motion speeds
- No wear
- Minimal lubrication required

2 MAIN SPINDLE

- Wide speed range
- C-axis for milling
- Spindle clamp
- A2-5 spindle nose
- Hollow clamping system $\varnothing 45$ (51 mm)
- Programmable clamping stroke monitor

3 MACHINE BASE

- Extremely rigid, welded-steel machine construction
- Compact design
- Very high thermostability
- Filled with vibration-absorbing material

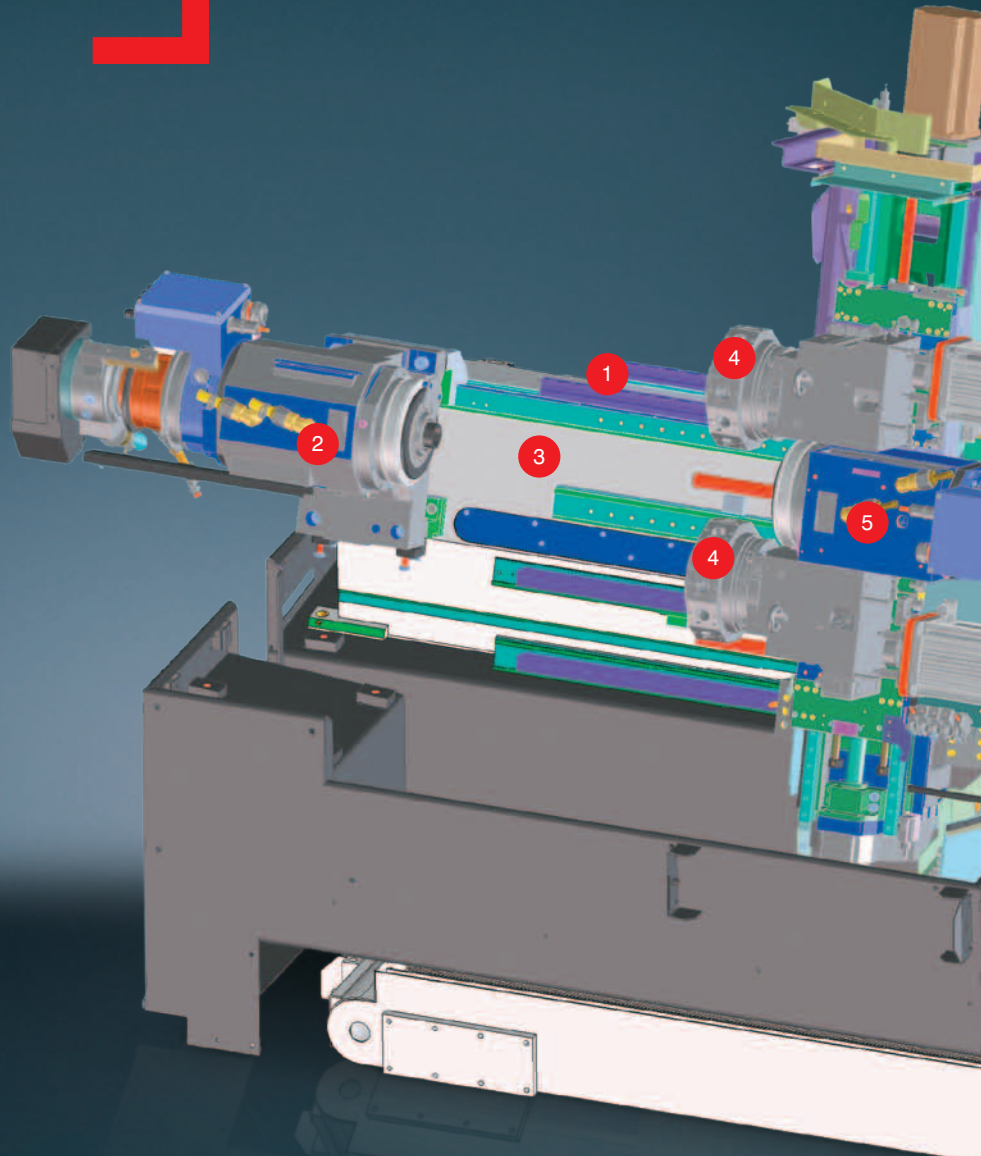

Performance and torque

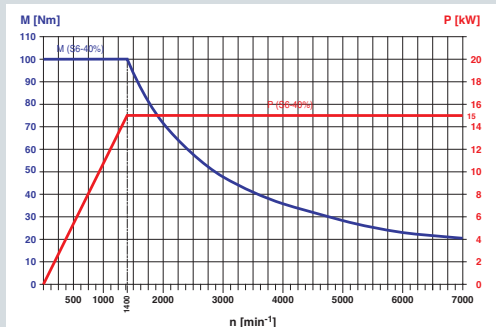

HYPERTURN 45 main spindle / counter spindle

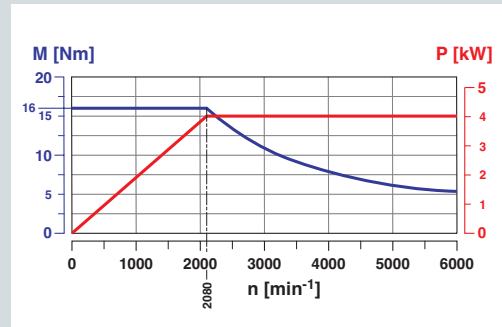

Tool turret - driven tools

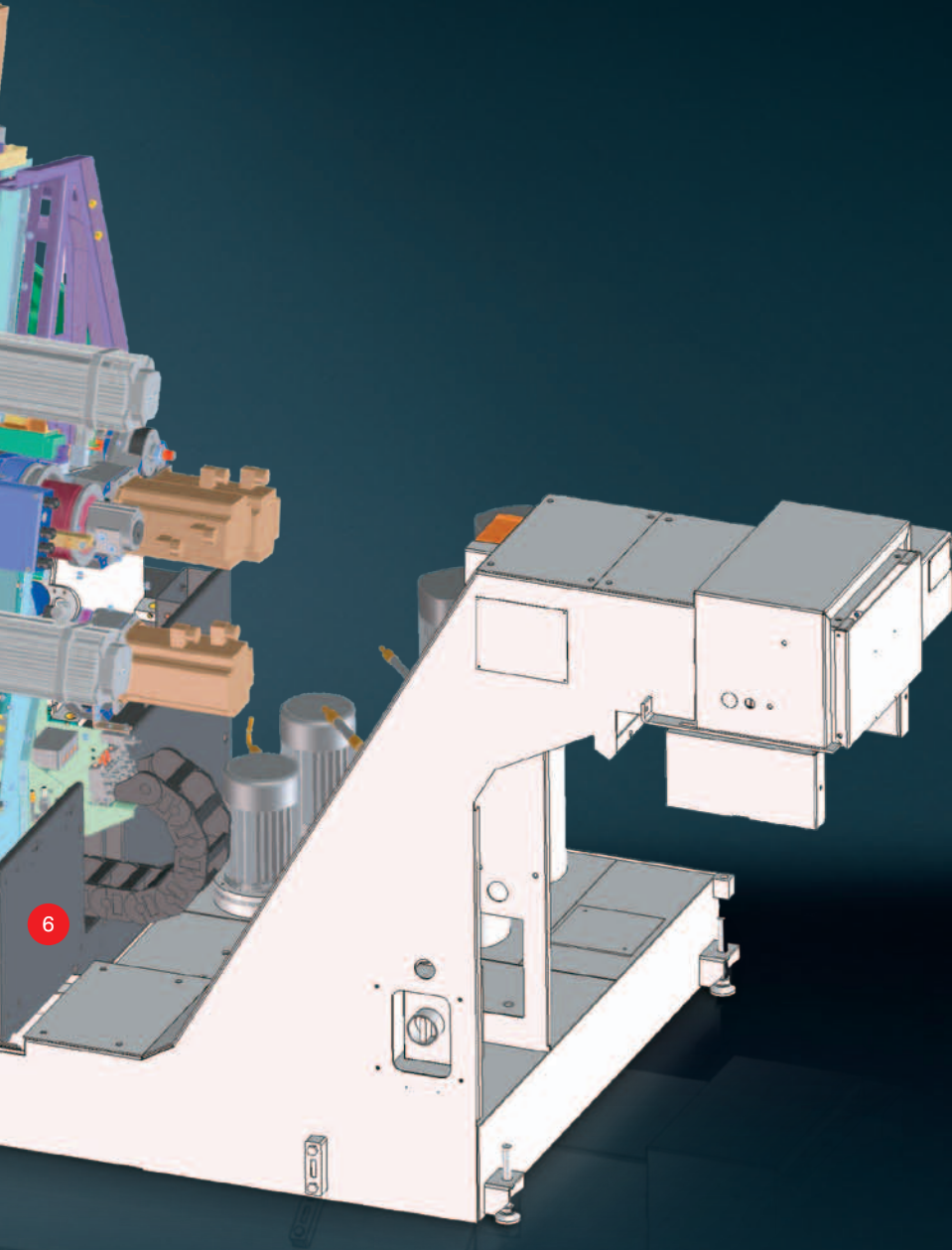

4 TOOL TURRET

- 2 x 12-position VDI25 turrets
- No alignment of the tool holder
- Can be used flexibly on both spindles
- Swivel speed adjustable with override

5 COUNTER SPINDLE

- Wide speed range
- C axis for milling
- Spindle clamp
- A2-5 spindle nose
- Full clamping system with parts ejector \varnothing 45 mm
- Programmable clamping stroke monitor

6 MACHINE STAND

- Solid welded-steel design
- Thermally separate from the machine base
- Filled with vibration-absorbing material
- 100% sealed against coolant leaks

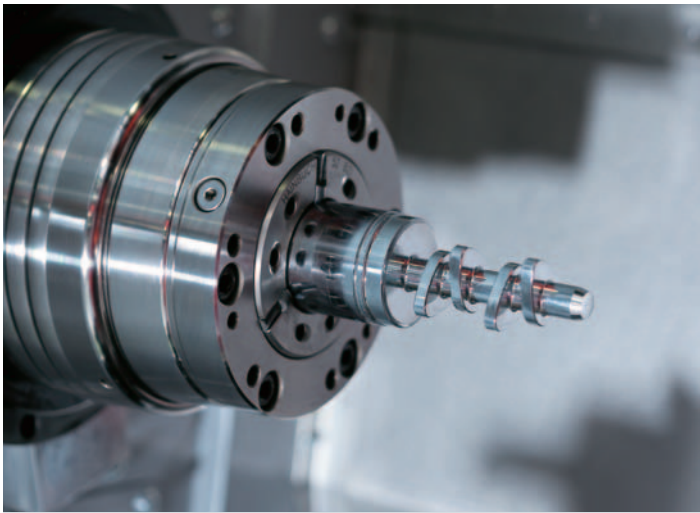

Main spindle. The 15 kW motor spindle with its integrated water cooling system provides high dynamics but low thermal displacement. A high-resolution shaft encoder provides the optimum conditions for accurate contour milling and drilling.

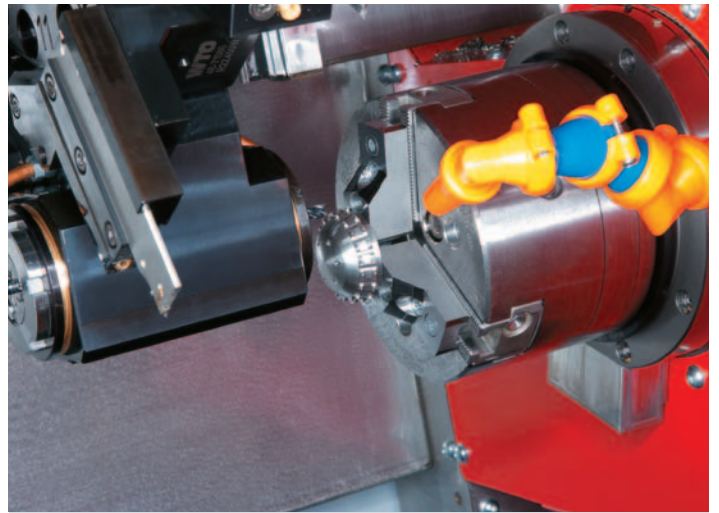

Counter spindle. A 15 kW, water-cooled spindle motor ensures dynamic performance and high levels of precision. The standard machine is equipped with a coolant-fed parts ejector. This places the finished workpieces in the parts catcher and at the same time clears the clamping surface from chips. Additionally, a flexible coolant pipe is mounted above the counter spindle for cleaning.



Parts catcher. The HYPERTURN 45's pneumatic parts catcher is controlled using M functions. When needed, it traverses to the front of the work area and travels to the spindle center. The finished part is removed from the clamping device and transferred to the catcher tray. The parts catcher then moves back to its initial position and the part is tipped into a catching box or onto a conveyor belt.

HYPERTURN 45 Technical

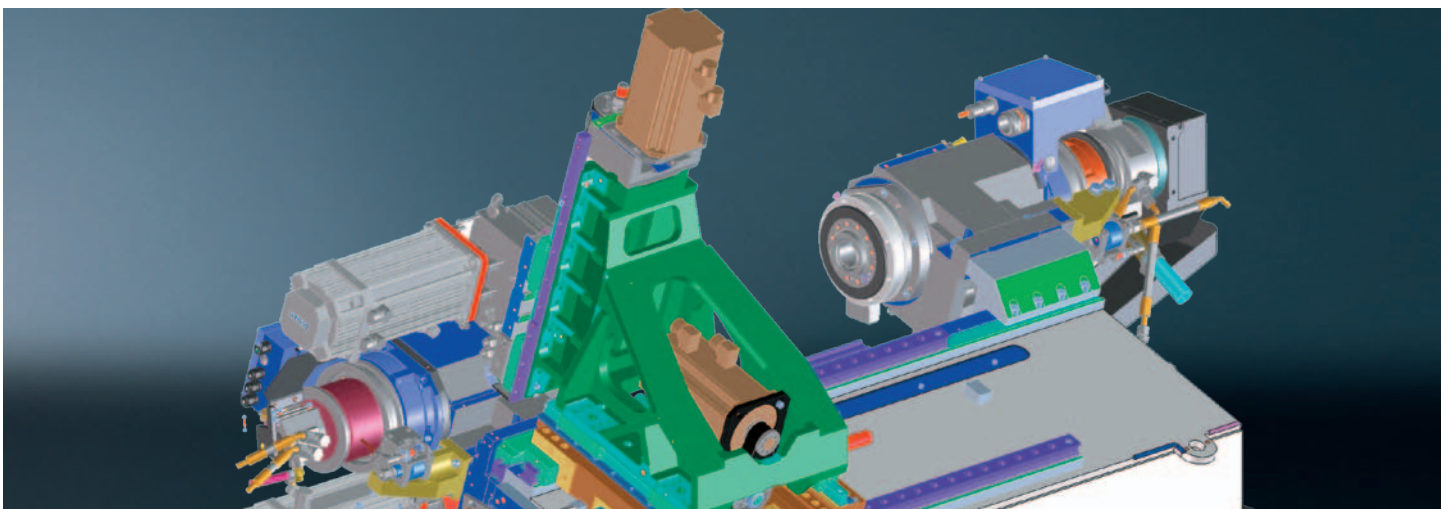

Y-axis. The Y axis is integrated into the basic machine structure and stands at 90° to the X axis. Extremely short projections form the basis for solid turning and drilling operations and also for milling operations without interference contours.

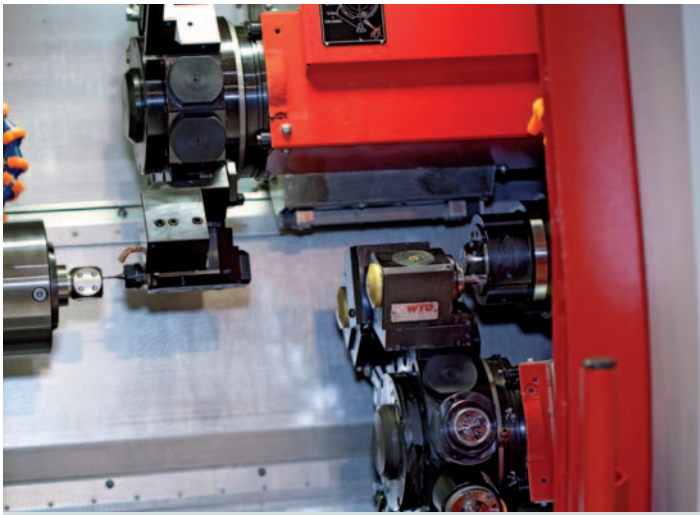

Tool turrets. Rapid 12-fold servo turrets with very short cycle times for standardised VDI25 tools. All stations may accommodate driven tool holders for drilling, milling or thread-cutting operations. The operator may influence the swing speed at any time.



Finished parts conveyor. The parts catcher deposits the finished parts on an accumulating conveyor with a usable storage area of 340 x 750 mm.

Highlights

Highlights

- Highly dynamic drives in all axes
- Two high-performance work spindles
- Two highly flexible, 12-station tool turrets
- Stable Y-axis with 70 mm travel
- State-of-the-art control and drive technology
- User-friendly dialog control with 3D graphics
- Compact dimensions
- Made in the Heart of Europe

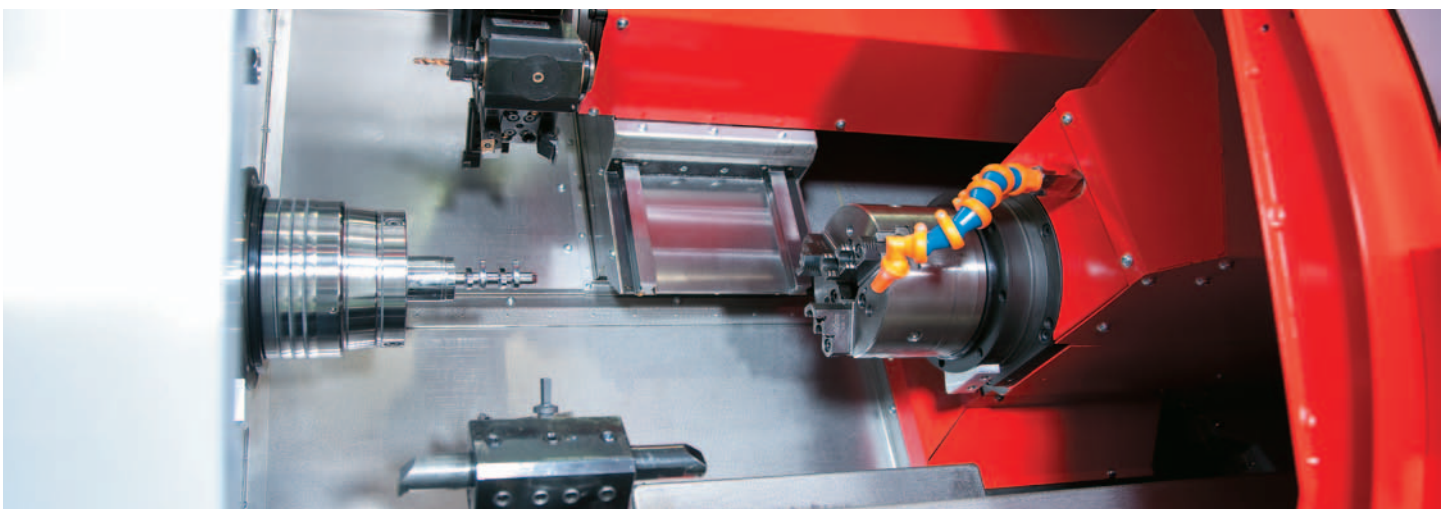

Work area. The generous work area provides space for several tools on both turrets and ensures a continuous chip flow even when few machine technicians are at work. Additional coolant pumps and a sophisticated pipe system clears the chips into the chip conveyor.



DASHBOARD – For a Quick Overview of the Machine Status

Clear and compact processing of all relevant machine and NC data depending on the configuration of the machine (number of tool systems, spindles, ...) and the active operating mode (JOG, MDA, AUTO). Know at a glance whether everything is OK or whether the machine operator will be required to interact.



emcoCONNECT's hardware basis is a 22" industrial touch control panel combined with an industrial PC (IPC).

Highlights

- Direct interaction between EMCO Apps and the control
- Intuitive user interface optimized for touch control
- Range of available applications is continuously being expanded
- Customised and project-specific applications
- Optimized for the EMCO machine range
- emcoCONNECT allows for easy and quick configuration and updating

er“ for ire production flow

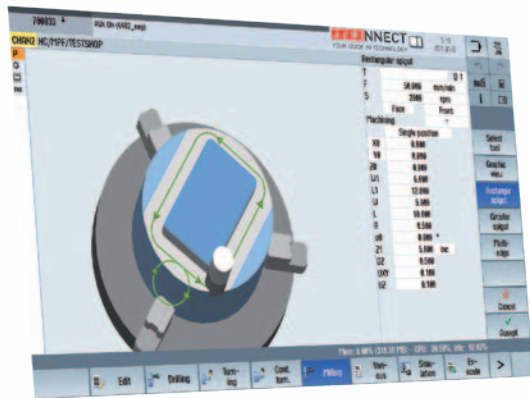

SINUMERIK - the Control and the Machine's Centerpiece

Thanks to the App Launcher operators may switch between the emcoCONNECT Apps and the control at any time. All it takes to do so is a click on the emcoCONNECT logo. To improve the work processes on the machine the control can, as shown in the picture, be operated in full screen mode or in interaction with practical apps (sidebar).

MACHINE DATA – All Data related to Productivity at a Glance

Operating data collection to inform the user about the current production status and OEE (Overall Equipment Effectiveness) values full screen or sidebar.

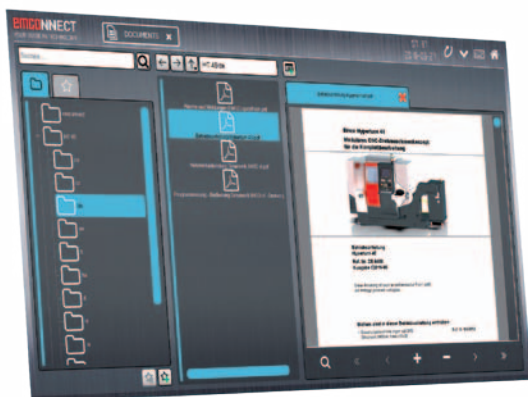

DOCUMENTS – A Digital and Expandable Document Collection Customised to Suit Your Individual Needs

To display PDF documents such as machine documentations, programming instructions, process descriptions ... Including favourites management - full screen or sidebar

Virtual workflow.

Real benefits.

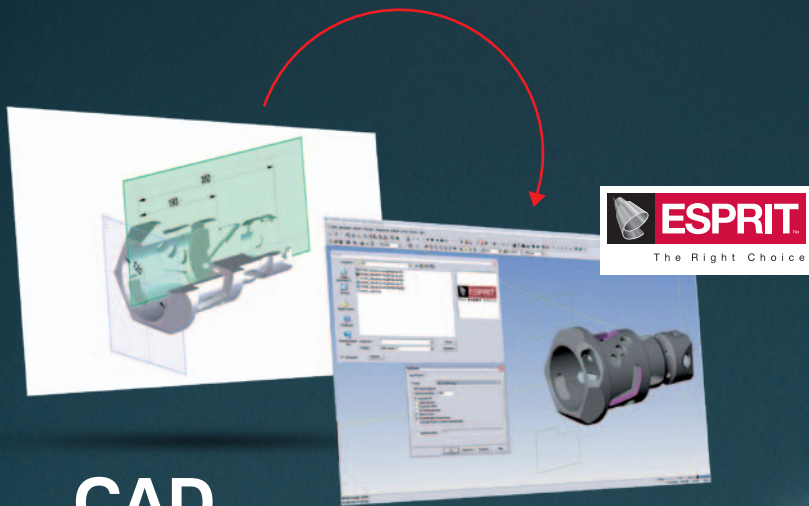

CAD

Direct CAD data import

- AutoCAD (DWG)
- Parasolid®
- Solid Edge®
- Solid Works®
- ACIS® (SAT)
- Optional interfaces: CATIA®, Pro/ENGINEER®, STEP, STL,...

CAM

- 2-22 axis turning
- 2-5 axis milling
- Multi-tasking of turning and milling
- 3D machine space simulation
- Certified post-processors

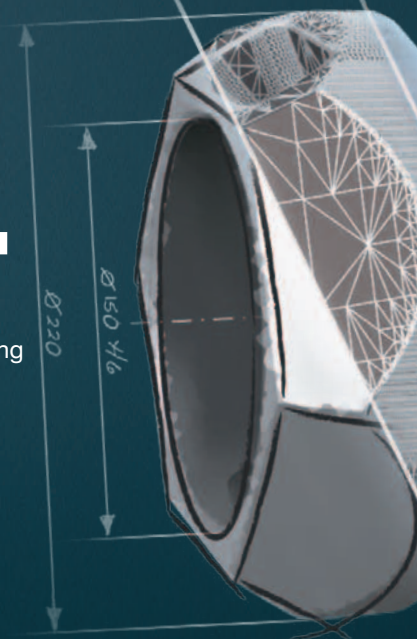
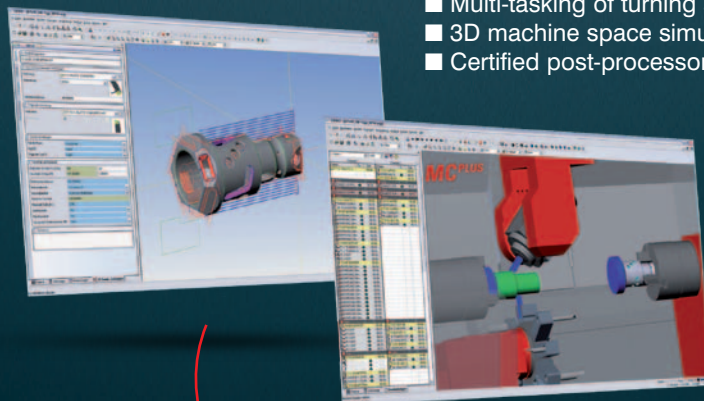

fits.

The Esprit CAM system offers high flexibility and process security, a comprehensive selection of machining cycles, maximum tool control, and cross-machine technology for your entire production facility. EMCO CPS Pilot provides for a 1:1 mapping of the real machine for defining and testing processes, optimizing machining sequences, and training new operators.



CPS

- 1:1 simulation with collision detection
- Direct connection to CAM ESPRIT
- Process optimization
- Reverse simulation of existing NC codes
- Reduction in scrap rates
- Training on the virtual machine
- Simulation of loading systems (e.g. EMCO gantry loader)

emcoCPS | Pilot
Die virtuelle Maschine

Production

- Reduction in set-up costs
- Reduction in downtimes
- Reduction in repair costs
- Optimum machine utilization



Options

There are many accessories and options available to help further customize the HYPERTURN 45. A generous selection of tool holders allows a wide range of machining options, including those you would not immediately associate with a turning center, including deep hole drilling, intermeshing, engraving, groove slotting and many more.

Antrieb 1		Antrieb 2		Antrieb 3	
BRUCH	Grenzalarm	BRUCH	Grenzalarm	BRUCH	Grenzalarm
0.6	12.2	0.4	6.7	0.6	32.3
150	00	00	120	00	00
493	55	2	104	25	102
	58		49		33%
	58		102		33%
	94		109		69%
	105		98		94%
	53		100		35%
	54		94		101
	55		100		103
			98		36%

Überwachung eingeschalten 1 Alarmreaktion eingeschalten 0

Grund-ein-stellung Grenzen sichern Parameter ändern Überw. ein/aus Alarmreakt ein/aus

EMCO tool breakage monitoring system

The tool status is monitored by evaluating the load on the various axis drive motors. Excessive loads point to wear or broken tools. Too low a load indicates a tool is missing.



Band filter system with high-pressure coolant pumps

A coolant pressure of 25/40/60/80 bar can be set as necessary. This enables coolant-fed drilling and milling tools to be used to their best advantage.

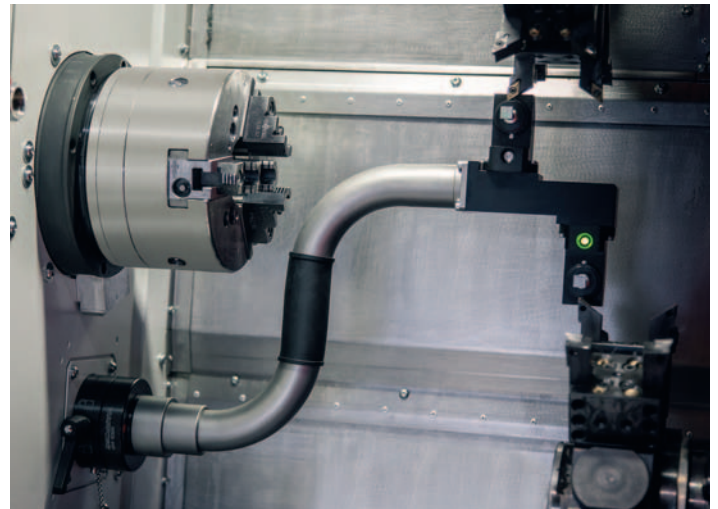

Tool gauge

The tool gauge allows tools to be measured quickly and accurately on both turrets in the work area. It is mounted manually in the holder in the work area and, after use, is replaced in a storage space in the machine housing.



Unloading through the counter spindle

Long, thin workpieces with diameters of up to 45 mm can be removed from the machine using the counter spindle. Parts are mostly stored on a sloping surface or, if necessary, also on a controlled conveyor to prevent any kind of damage occurring.

Maximum output – minimum space required.



The EMCO swing loader is a universal loading system for all types of pre-formed blanks. It can be customized individually to the customer's requirements using numerous gripper and handling systems. How we do it: we standardize the components but create a customized solution. The result: a custom-tailored machine for the same price as a standard unit.



High-capacity timed conveyor system for correct directional loading of pre-formed blanks

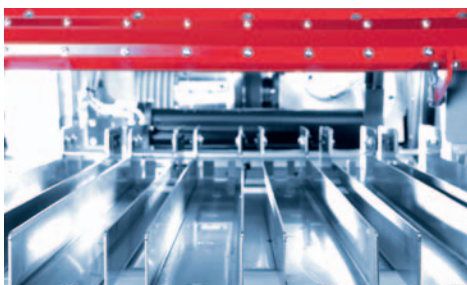

Multiple infeed chutes for loading rotationally-symmetrical blanks; the length of the blanks determines the number of infeed chutes.

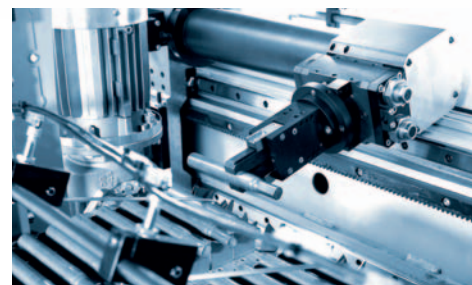

Timed conveyor system with V-supports for preformed shaft parts of various shapes.



Multiple infeed chutes for loading rotationally symmetrical blanks. A sensor monitors the availability of blank parts for each infeed chute.



Shaft gripper for automatically loading pre-formed shafts.



Fully automatic shaft loading. Feed-in via a conveyor belt, removal via the finished parts pick-up device

Blank part feeding systems

Feed systems specific to particular blanks allow pre-formed workpieces to be loaded into the work spindle in the right direction, allowing manufacturing with minimal personnel requirements.

Customization

A wide range of gripper and handling systems is available.

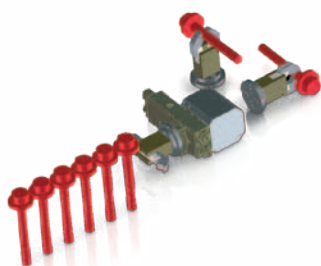

2-finger gripper with 180° rotary module for loading vertically fed blanks

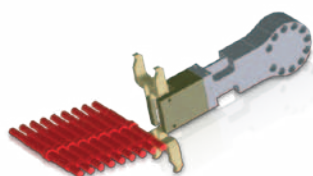

2-finger toggle lever gripper for loading shaft parts

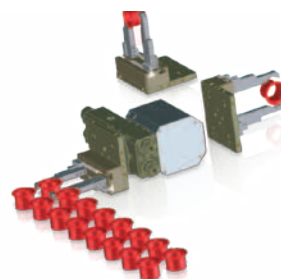

Parallel grippers with 180° rotary module for loading shaft parts (1st and 2nd clamping cycle)

EMCO TOP LOAD.

The premium class.

Quality by the meter. The EMCO TOP LOAD series was designed to automatically load 3-meter long bar stock into EMCO machines. Loaders are available for diameters of 4 - 25 mm, 8 - 42 mm, and 10 - 65 mm. Bar stock measuring up to 42 mm in diameter can be loaded using the EMCO TOP LOAD 8-42/3200. The oil coolant-fed loading channel, lined with plastic shells, reduces vibrations to a minimum, even at high speeds. Bar stock is fed in via a servo motor which controls both the speed and feed force. A patented guidance system with several guidance rests guarantees optimum feed quality. Time-consuming conversions and channel changes are no longer necessary. The bar loader can be switched from one diameter to another in just a minute or two.



EMCO TOP LOAD 8-42/3200 in SINGLE-LEVEL version

In SINGLE LEVEL mode. Bar stock is laid on a slanted feed track (280 mm) and falls into the guide channel one by one. Optionally, the MULTI-LEVEL version is also available. In this case, bar material can be stored on several levels (3x 300 mm), thus maximizing manless operation.

The EMCO short bar loaders. Universal, high-performance.

Short and to the point. The EMCO SL1200 is the perfect solution for automatic feeding and loading of cut-to-length bars. The key advantages are a small footprint and rapid loading times resulting from shorter strokes.

The technology. The SL1200 can be used immediately as a „plug-and-play“ solution. Their extremely small footprint enables processes to be automated even if space is tight. Apart from complying with the latest safety requirements, it is easy to operate and moveable for service purposes. Besides, it can comfortably be incorporated into the production process using the machine control's programme input masks.

Technical data	SL1200
Bar diameter	Ø 8 – 95 mm
Max. bar length	1200 mm
Min. bar length	150 mm
Material storage length	approx. 560 mm
Feed rate	0 – 60 m/min
Bar change time	approx. 15 sec.
Dimensions (L x W)	1700 x 1250 mm
Weight	approx. 500 kg

The benefits

- Smaller footprint
- Easy to use
- Short feed times
- Fast, straightforward changeover
- Option to load individual workpieces
- Central diameter adjustment
- Dedicated control
- The loader operates without oil
- Ergonomic EMCO design



EMCO SL1200. Space-saving and cost-effective bar loading magazine. Operation and programming could not be easier. May also be used for loading single items through the lathe's main spindle.

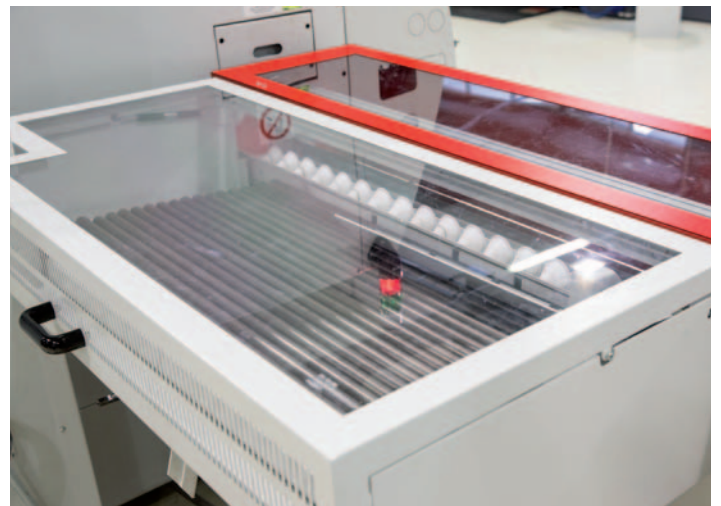

Material storage. The material storage surface with a length of 560 mm is arranged at the rear of the bar loader in a manner with no influence whatsoever on the space available. Depending on the diameter it is possible to store a different number of short bars.

Machine layout HYPERTURN 45 with EMCO SL1200

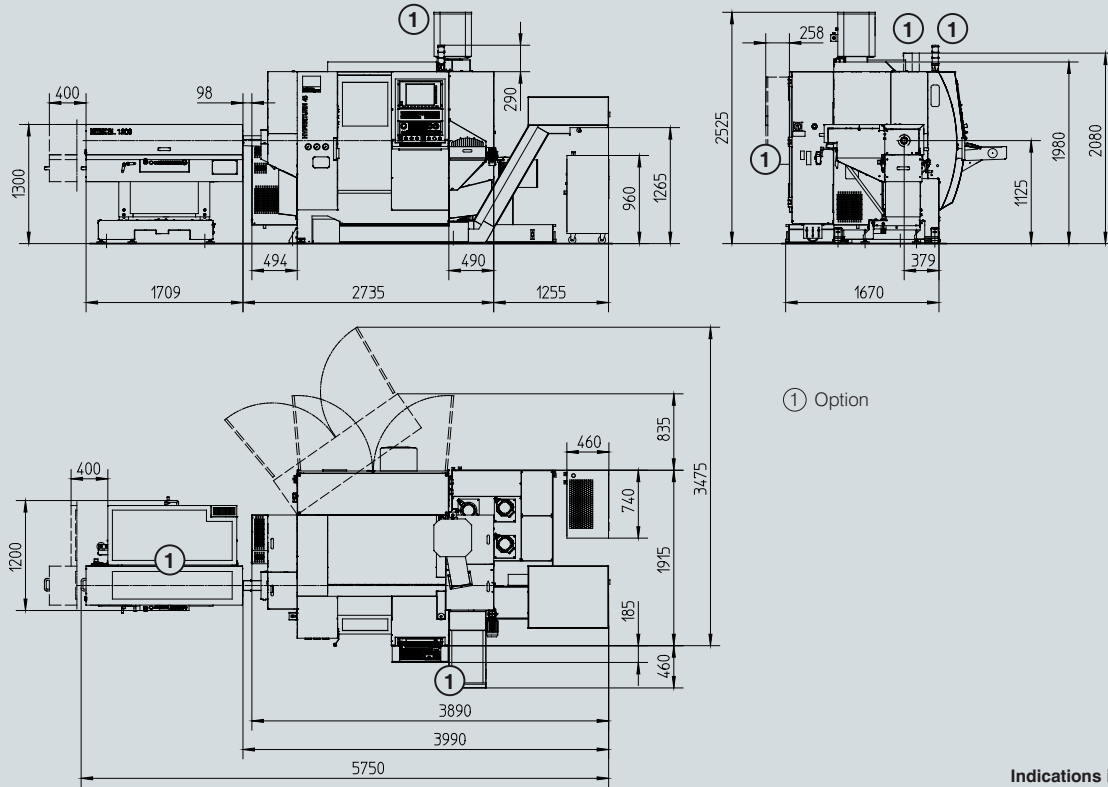

Layout EMCO TOP LOAD 8-42/3200

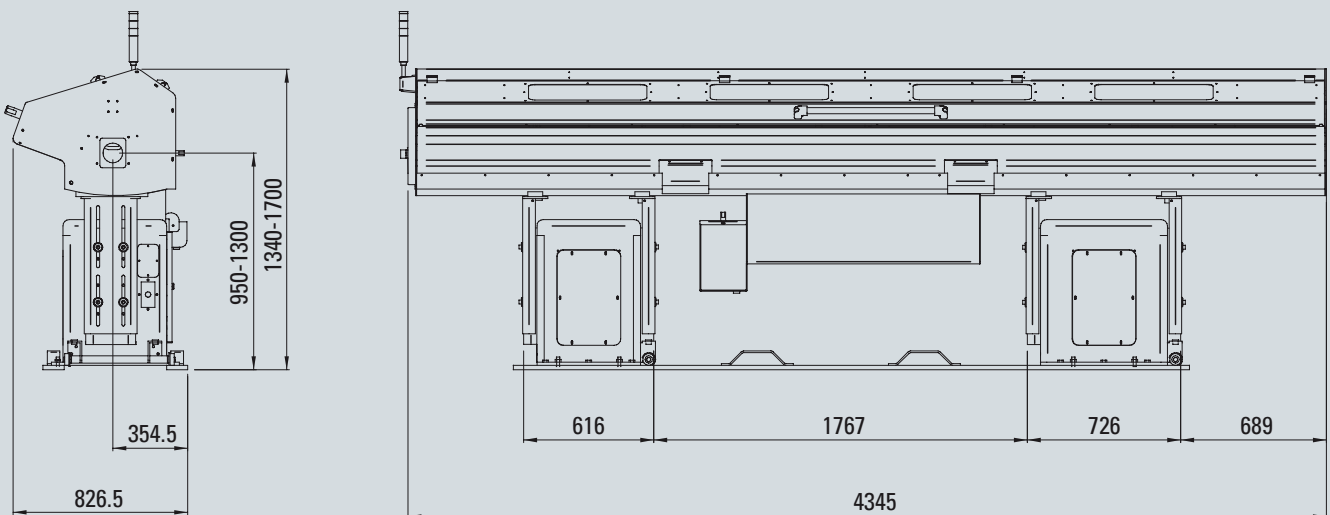

HYPERTURN 45 SMY work area layout

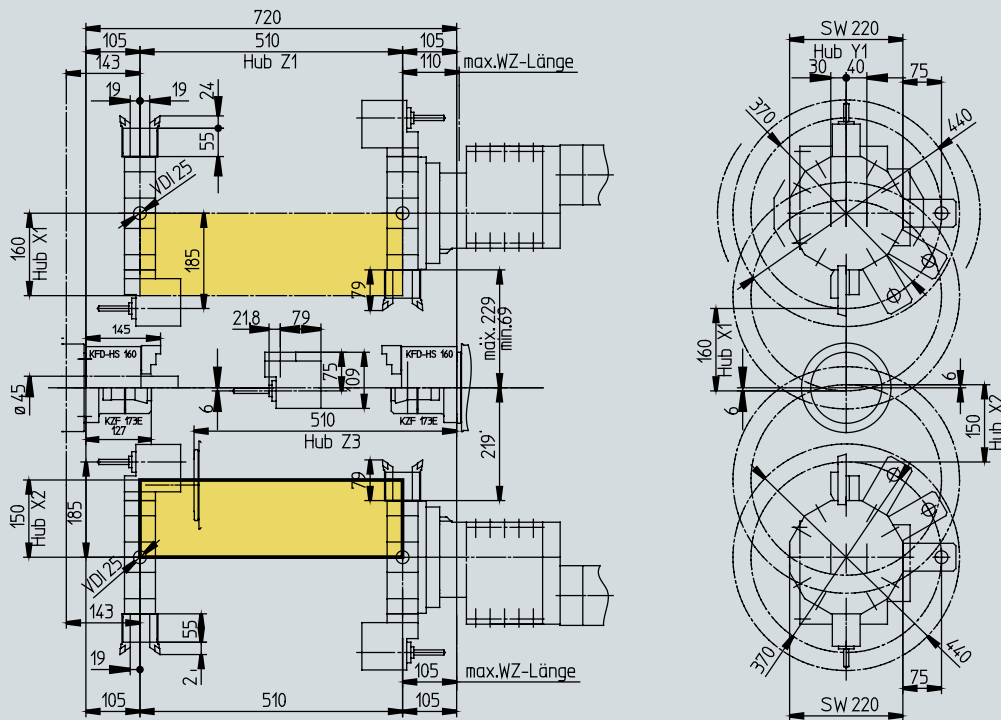

Indications in millimeters

Machine layout HT45 with EMCO swing loader

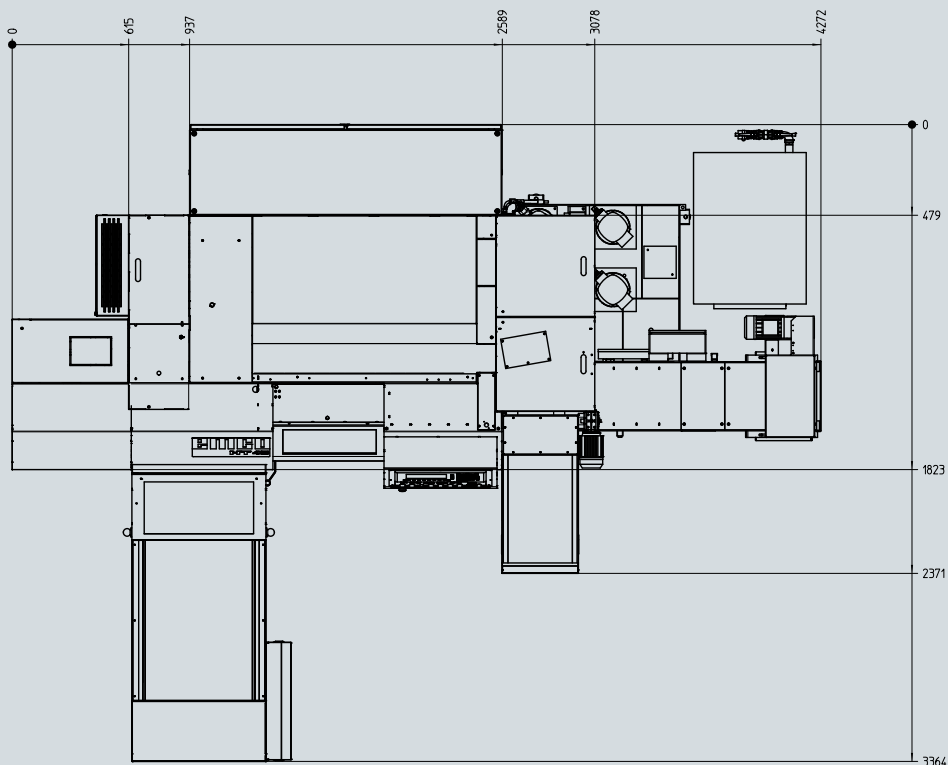

Indications in millimeters

Quality Components

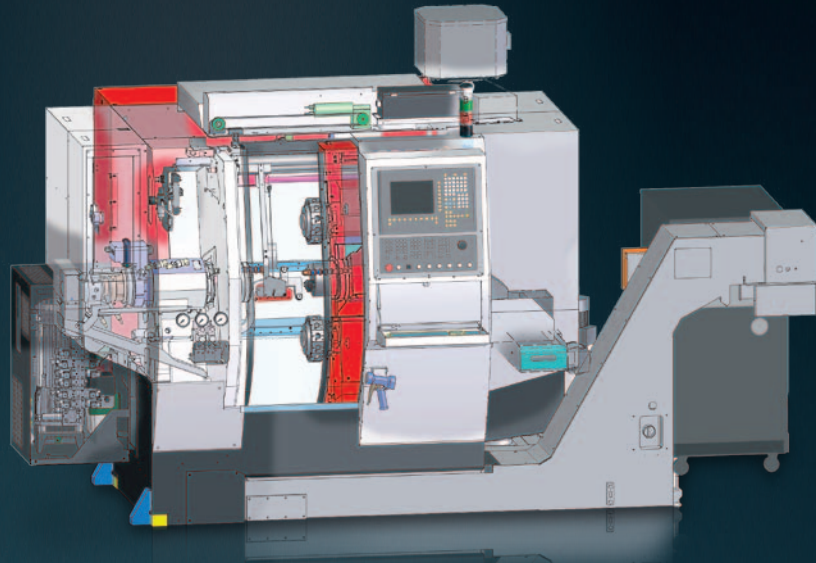

Coolant pumps

Low-maintenance immersion pumps for pressures of up to 25 bar and flow rates of up to 1500 l/min provide optimum conditions for machining and enable reliable chip transportation.



Clamping cylinder / chuck

Hydraulically activated clamping cylinders and chucks guarantee the precise, safe clamping of work pieces. Programmable sensors are used for stroke monitoring. There is no need for time-consuming adjustments of contactless limit switches.



Tool holder

Innovative, fully developed tool holder systems form the basis for cost-effective machining. High changeover accuracy and stability result in short setup and cycle times.



Headstocks

The design and manufacture of headstocks are two of EMCO's core competencies. During engineering, the focus is on precision, robustness, high rigidity, precise rotational characteristics, and a long service life.



Hydraulic systems

Compact dimensions, quiet operation, and high energy efficiency - just some of the advantages of the hydraulic assemblies used by EMCO. Monitored pressure switches prevent the need for time-consuming manual pressure adjustments.

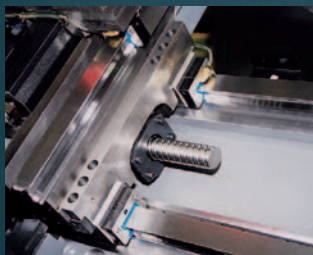

Machine bases and slides

When matching components, we place great value on high stability, good damping characteristics, and a thermoneutral design. We achieve high stability through a shorter force flow, thermal stability through symmetry, and dampening through the materials and interfaces selected.

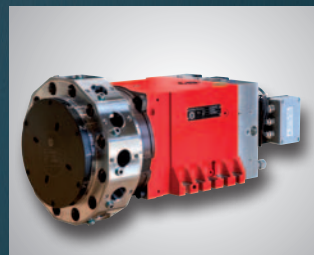

Tool turret

Rapid-indexing turrets with adjustable swivel speeds and milling drives represent the current state of the art. The backlash-free milling drive is not only ideal for milling and drilling, but also for rigid tapping, hobbing, and polygonal turning.

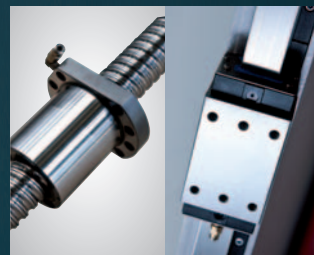

Ball screws and roller guides

Highly precise and generously dimensioned guide rails and ball screws with optimal pretensioning form the basis for the machining of precision parts.



Chip conveyor

Slat band conveyors allow for flexible implementation and the safe removal of chips. A monitored overload clutch prevents damage from improper use.

Minimum use of resources for maximum profit.



At EMCO, we take a consistent, responsible approach to the use of resources in machine tools in order to safeguard long-term investments. From the development of our machines through to their construction and manufacture, we place a strong focus on the sensible and sparing use of raw materials and energy. This enables us to achieve parallel savings in two areas:

1. Reduction in the basic power consumption of machine tools, e.g. assemblies are switched on and off as required and the installed connected loads are kept to a minimum.
2. Reduction in variable consumption: This can be seen in the lighter axes, energy recovery system, increased rate of good parts, and the shorter process chain enabled by complete machining.

Through these measures, which are constantly being refined and further optimized, EMCO truly demonstrates that its slogan of „Designed for your Profit“ is not just an empty promise: EMCO products help save the environment and provide intelligent customer savings without compromising on quality and flexibility.

[Regenerative drive system]

Kinetic energy is converted into electrical energy and fed back into the grid.
Savings of up to 10%

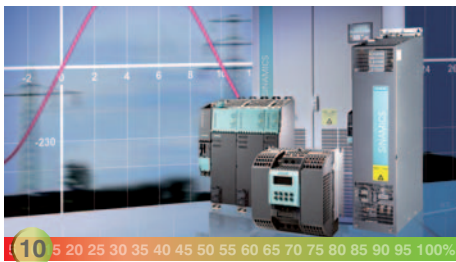

[Compact hydraulics unit with pressure accumulator]

Thanks to its accumulator charging system, the pump only runs when required. If the pressure accumulator is full, the pump switches over to closed loop circulation.
Savings of up to 90%



[Roller guides]

Extremely low friction losses thanks to rolling friction. Highly dynamic performance with minimal lubricant consumption.
Savings of up to 50%

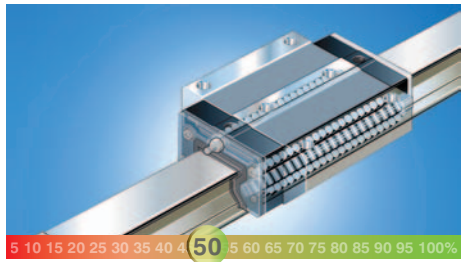

[Structurally optimized mechanics]

FEM analysis is used to optimize the relevant components in terms of their rigidity while simultaneously reducing their weight.
Savings of up to 10%

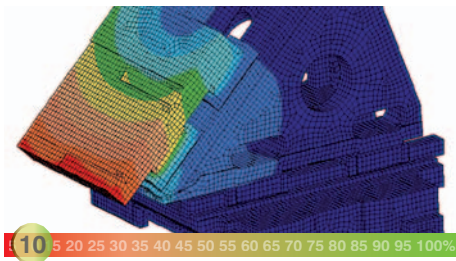

[Highly efficient motors]

The use of energy-efficient motors (IE2) in the coolant preparation area guarantee highly cost-effective operation.
Savings of up to 10%



[Synchronized chip conveyor]

Programmable interval times enable optimal use of the chip conveyor independently of the machining process.
Savings of up to 95%

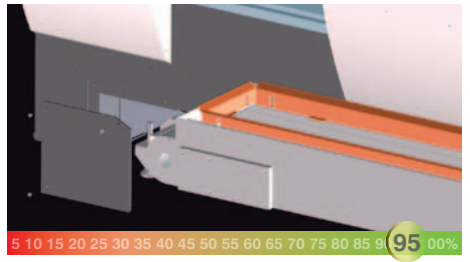

[Intelligent standby concepts]

Reduced consumption by automatically switching off ancillary units and machine space/screen illumination after a defined period of inactivity on the control panel.
Savings of up to 50%



[Virtual machine]

Significant reduction in the setup and running-in times on the machine through the use of highly developed simulation and programming software.
Savings of up to 85%

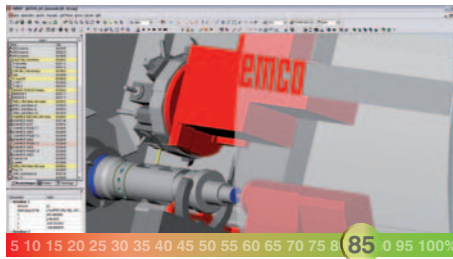

[Intelligent energy management]

Intuitive data entry screens for activating the individual energy-saving functions.
Savings of up to 70%

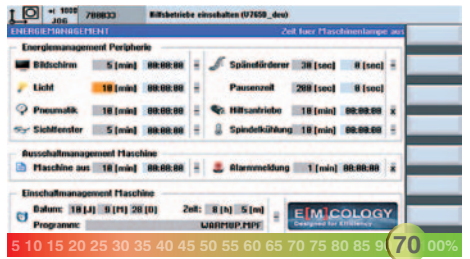

HYPERTURN 45

Technical Data

Working area

Swing over bed	Ø 430 mm
Swing over cross slide	Ø 300 mm
Distance from main spindle to counter spindle	720 mm
Max. turning diameter	Ø 300 mm
Max. part length	480 mm
Max. bar capacity	Ø 45 (51) mm

Travel

Slide travel in X / X2	160 / 150 mm
Slide travel in Z / Z2 / Z3	510 / 510 / 510 mm
Travel in Y	+40 / -30 mm

Main spindle

Speed range	0 – 7000 rpm
Max. torque on the spindle	100 Nm
Spindle nose DIN 55026	A2-5
Spindle bearing (inner diameter at front)	Ø 85 mm
Spindle bore	Ø 53 mm

Counter spindle

Speed range	0 – 7000 rpm
Max. torque on the spindle	100 Nm
Spindle nose DIN 55026	A2-5
Spindle bearing (inner diameter at front)	Ø 85 mm
Spindle bore	Ø 53 mm

C axis

Resolution	0,001°
Rapid motion speed	1000 rpm
Spindle indexing (disc brake)	0,01°

Drive power

Main spindle	15 kW
Counter spindle	15 kW

Tool turrets 1+2

Number of tool positions	2 x 12
Tool holding shaft in accordance with VDI (DIN 69880)	VDI 25
Tool cross section for square tools	16 x 16 mm
Shank diameter for boring bars	Ø 25 mm
Revolver switch time	0,2 sec

Driven tools 1+2

Speed range	0 – 6000 U/min
Torque	16 Nm
Drive performance	4 kW
Number of driven tools	2 x 12

Feed drives

Rapid motion speed X / Y / Z	30 / 15 / 45 m/min
Feed force in the X axes / Y axis	4000 N
Feed force in the Z axis	5000 N
Feed force in the Z axis counter spindle	6000 N
Position variation Ps (VDI 3441) X / Y / Z	3 / 3 / 3 µm

Coolant system

Tank volume	300 l
Coolant pumps for the tool turret	2 x 14 bar
Flushing pumps for the work area	2 x 3,7 bar

Power consumption

Connected load	30 kVA
Supply pressure	6 bar

Dimensions/weight

Height of center above floor	1126 mm
Machine height	1985 mm
Space occupied BxT (not including chip conveyor and coolant) Kühler)	2650 x 1950 mm
Total weight of machine	4200 kg

Safety devices CE compliant