

emco group

Designed for your profit

Hyperturn 200 Powermill

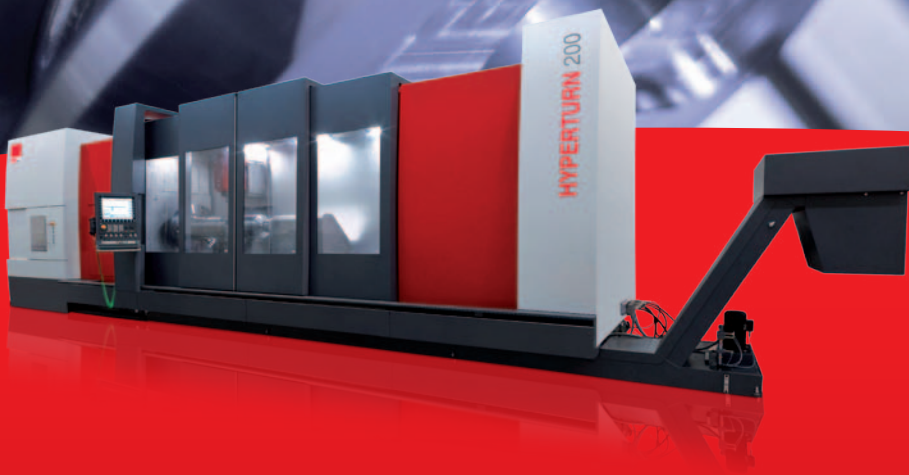

Turn/Mill center for the complete machining
of large workpieces

TURNING
EMCO-WORLD.COM

Multifunctional Profit Centre.

EMCO Mecoff's milling know-how meets Emco's turning expertise. Benefit from more power, higher precision and increased productivity when it comes to the machining of large workpieces – and all of this in just one setting.

1 MAIN SPINDLE

- Double-gear motor for zero backlash C-axis
- Impressive performance: 84 kW - 6410 Nm - 1800 rpm
- Spindle nose A2-15"

2 X-, Z-, Y-AXES

- Heidenhain glasscales in all axes
- High feed force
- Tailstock and steady-rest nc-controlled
- High and stable dimensioning in all axes

3 MACHINE DESIGN

- Optimal use of space
- Innovative chip and coolant protection system
- Large work area
- Ergonomic accessibility
- Chip flushing system in the work area (standard)

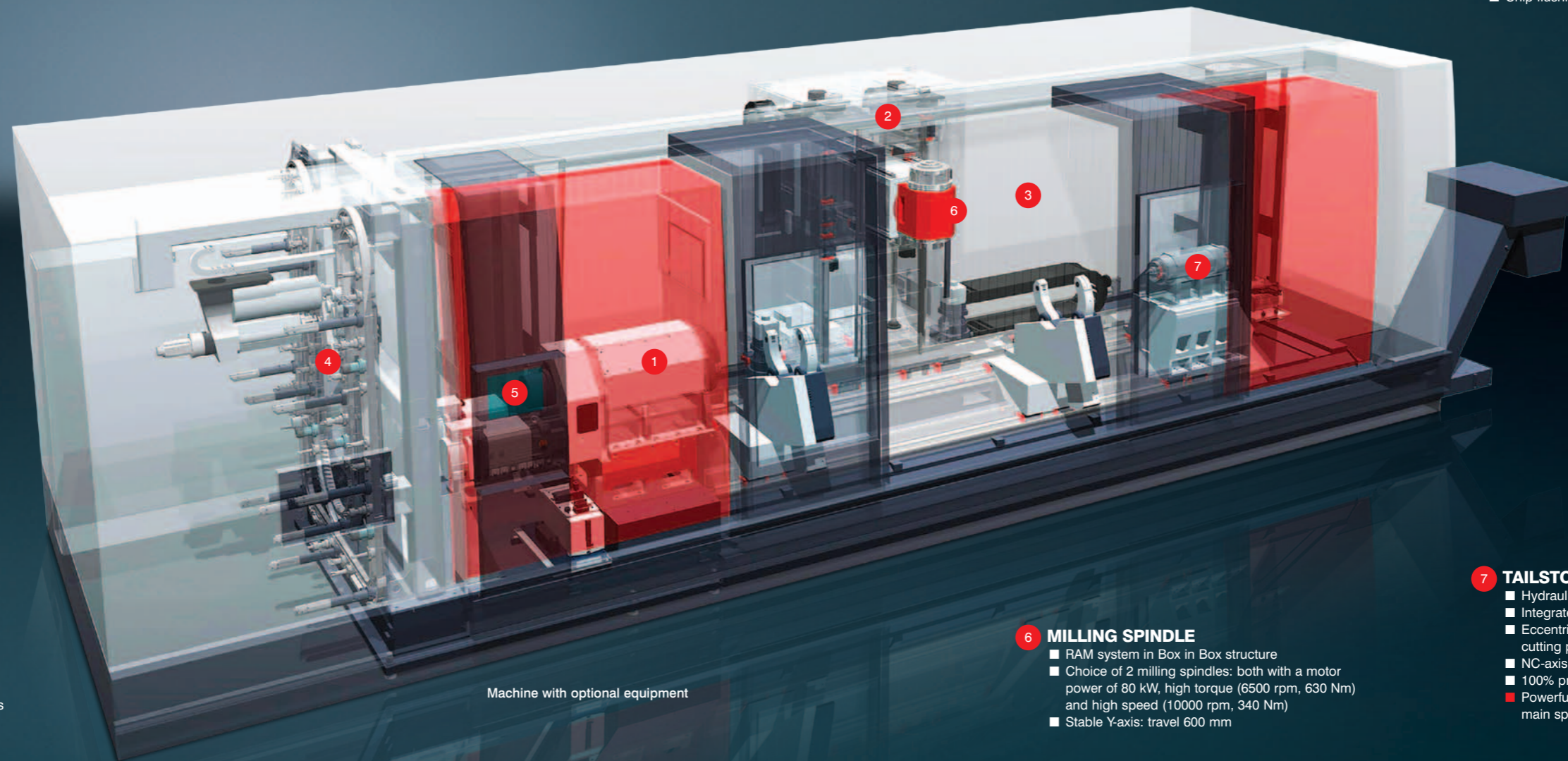

Machine with optional equipment

4 TOOL MAGAZINE

- Optimal accessibility for tool assembly and inspection
- Up to 200 tool stations
- 3 additional stations for boring bars and long tools

5 CONTROL

- Sinumerik 840D sl with 19" color screen
- USB interface
- Swiveling and movable control panel
- EMCO technology cycles
- AURIGA process assistant

6 MILLING SPINDLE

- RAM system in Box in Box structure
- Choice of 2 milling spindles: both with a motor power of 80 kW, high torque (6500 rpm, 630 Nm) and high speed (10000 rpm, 340 Nm)
- Stable Y-axis: travel 600 mm

7 TAILSTOCK

- Hydraulic quill
- Integrated bearings
- Eccentric quill settings for simplified cutting process
- NC-axis positioning
- 100% programmable and monitored
- Powerful counter-spindle, identical to the main spindle

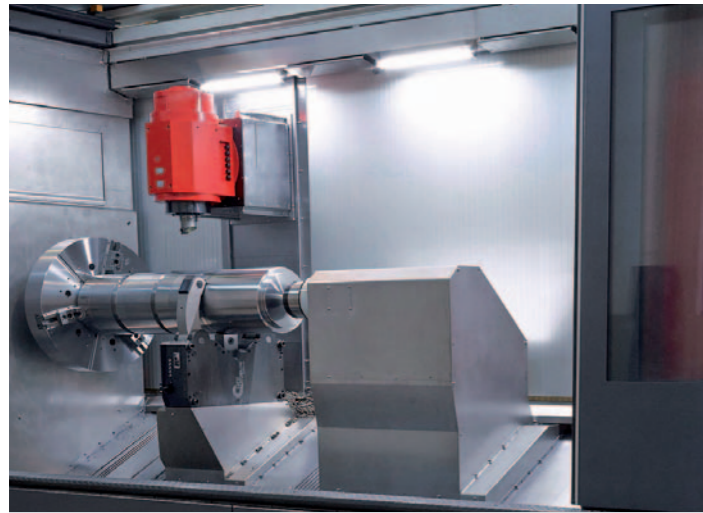

Main spindle. For turning and milling operations, equipped with 84 kW and 6400 Nm torque. Sealing air, working area coolant and programmable clamping pressure are standard features on the Hyperturn 200. One or more programmable NC steady rest can assist the processing.

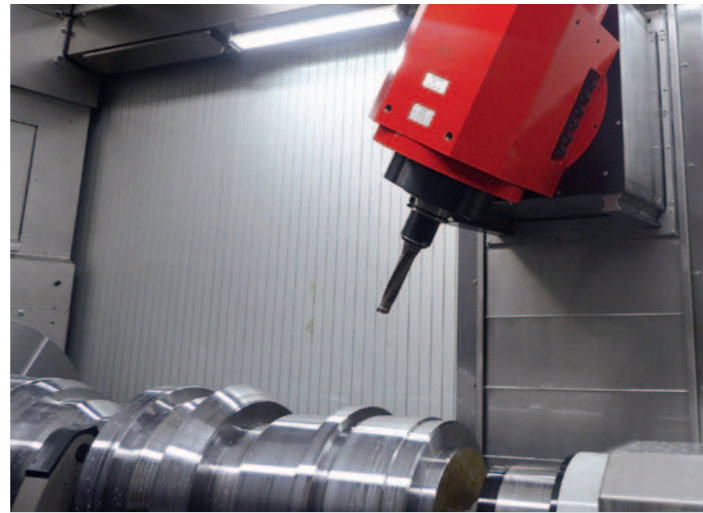

Milling spindle. For stable, precise and flexible drilling and milling operations. Up to 80 kW and 630 Nm of torque and 10000 rpm. Sealing air, internal HP coolant with 40 bar and externally with 14 bar and a 1400 liter paper band filter system as standard (80 bar option). The B-axis can be used at any angle or with an indexed B-axis in 2.5° steps.

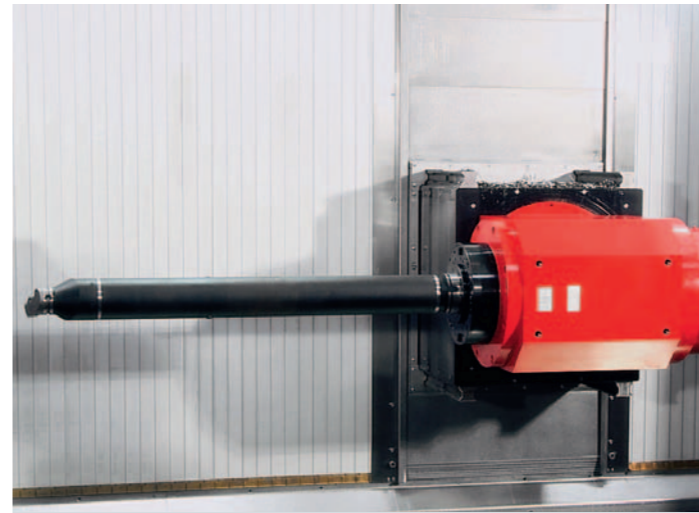

Turning operations. External or internal turning operations are possible with the stable spindle in 3° step. Optionally, the vibration-damped boring bar can be equipped up to a length of 1000 mm and with a 3-positions (stations) pick-up magazine.

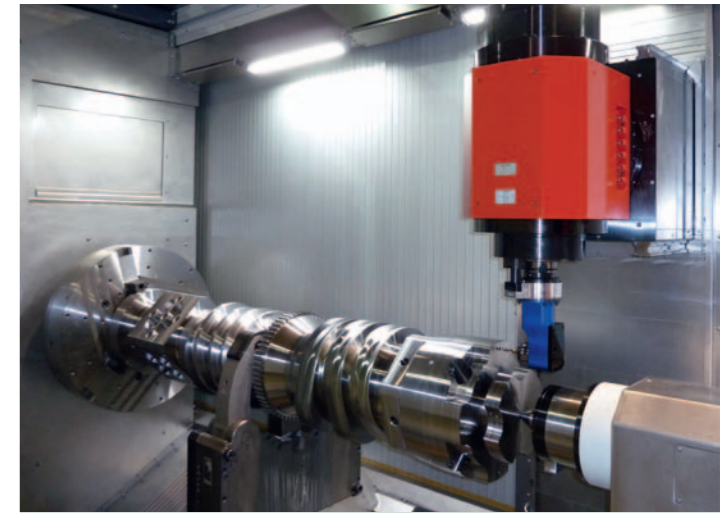

Machining options. From an angular tool holder to an additional U-axis – all machining processes are possible and feasible in a customised way.

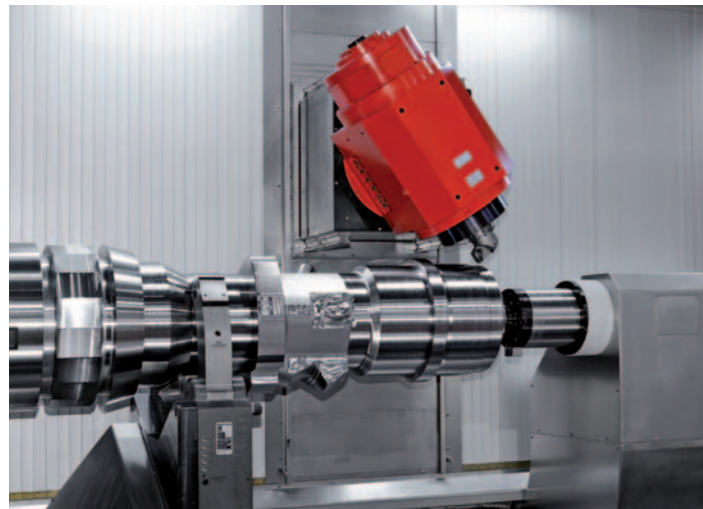

Tailstock. The tailstock is 100% programmable using the control. With the high-quality and precisely-dimensioned MK6 quill, all operations can be supported or extended with the counter spindle thanks to the machine modular construction.

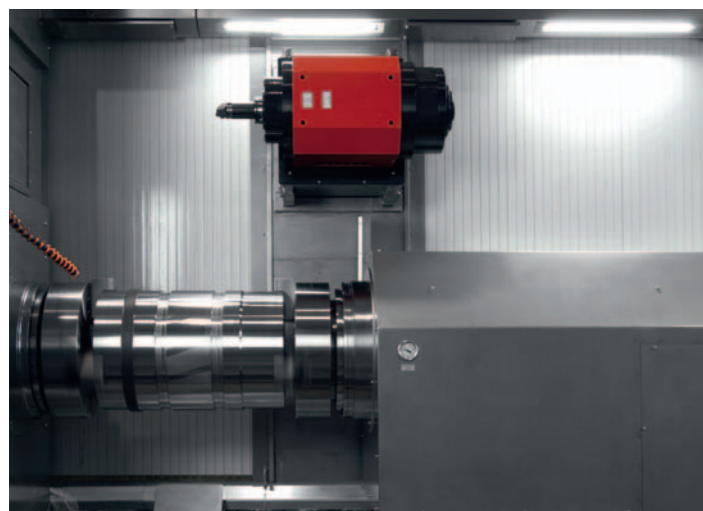

Powerful counter-spindle. The counter-spindle and main spindle are identical when it comes to their specifications and construction. Thus, it is possible to machine even more complex parts in one setting. This results in more flexibility, increased productivity and lower storage costs for the customer.



Moving column. Is constructed like the EMCO MECOF machines with a „Box-in-Box“ RAM structure. Thus, optimum rigidity and stability are ensured and high accuracy machining is guaranteed. The B-axis is equipped with a torque motor and integrated into the Ram design.

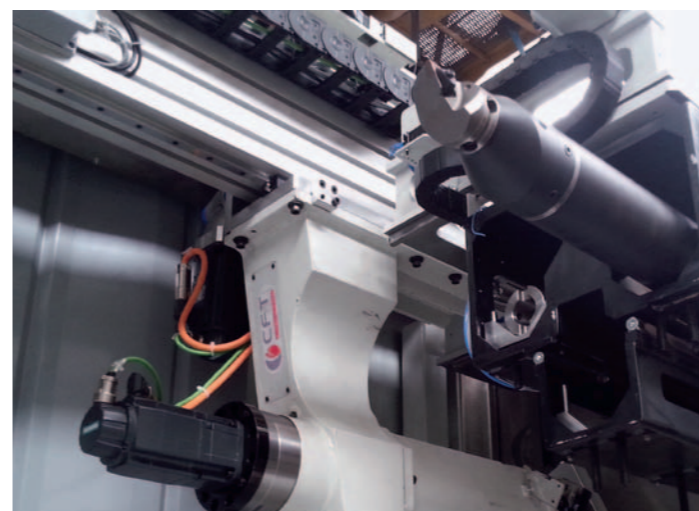

XL magazine. Equipped with a 3-positions pick-up magazine, it includes tools up to a length of 1000 mm

Hyperturn 200 Powermill Technical Highlights

Highlights

- Very large working space for the complete machining of large workpieces up to a turning diameter of 1000 mm with a maximum length of 6100 mm
- Moving column with box-in-box structure for maximum stability
- High-performance main spindle and Counter Spindle for heavy cutting at 84 kW and 6400 Nm
- Dynamic and precise B-axis with high torque and power
- Two versions of milling spindles with 6500 or 10000 rpm, with HSK-T 100 or PSC80 (Capto C8)
- Multitasking-control - Multi-technology SINUMERIK 840D sl
- Main spindle and Counter Spindle for high-performance processing with vibration-damped boring bars up to 1000 mm, including a special magazine (optional)
- Automatic tool presetting and workpiece measuring touch probe
- One or more NC steady rest
- 100 / 200 tool magazine positions
- High-speed milling spindle at 10000 rpm
- Boring bar pick-up system
- 5-axis simultaneous machining
- Coolant pressure 80 bar
- Virtual machine - collision monitoring
- EMCO remote/network service
- Tool load monitoring
- Made in the Heart of Europe

Flexibility, Precision and Maximum Productivity With High Machining Performance.

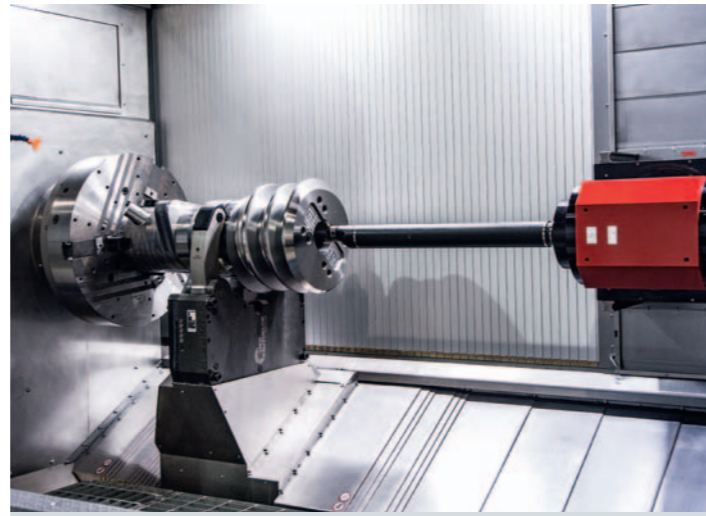

Boring bar: Boring bar with vibration absorption featuring a diameter of 100 x 100 mm for internal turning operations. There are three specifically dimensioned tools available.

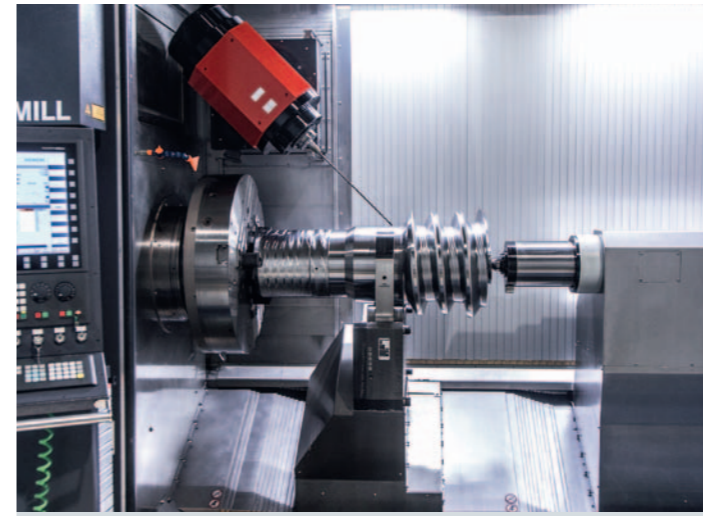

Deep hole drilling for diameters of up to 6 x 500 mm with a maximum of 80 bar

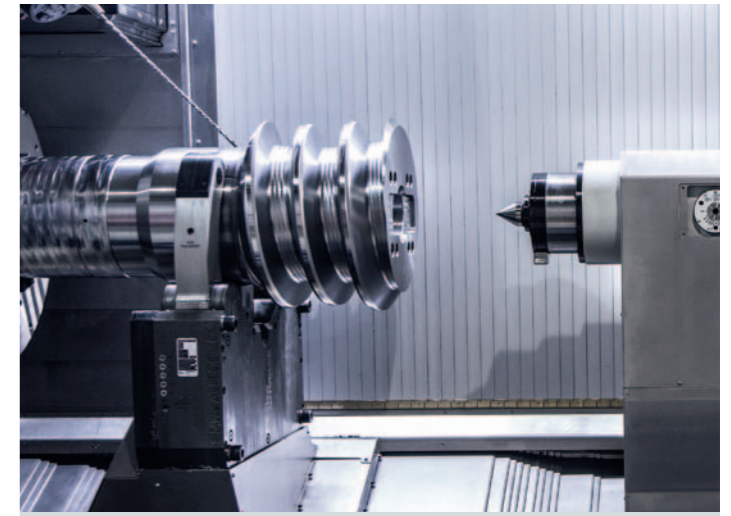

Tailstock: adjustable tailstock (MK6) for a workpiece weight of up to 6 t

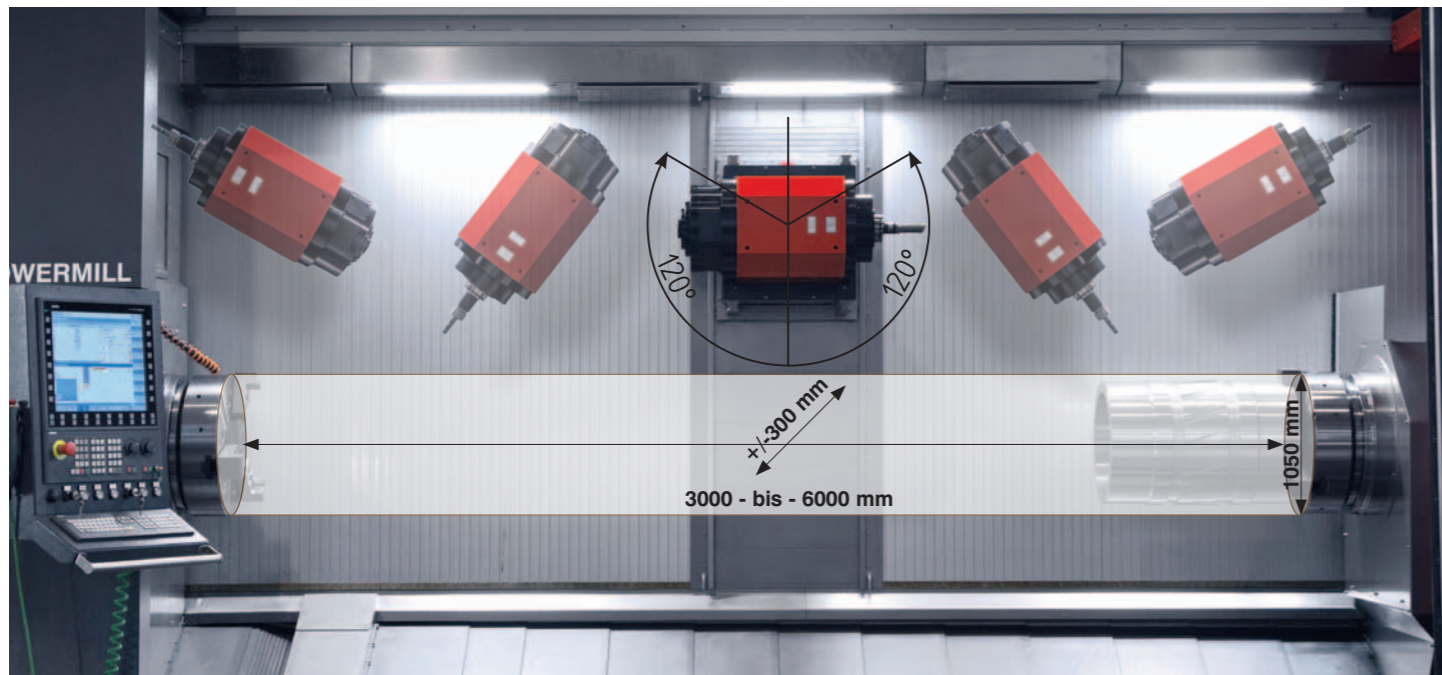

Ergonomic Access to the Work Area



Ergonomic loading of the tool magazine with tools weighing up to 25 kg and measuring more than 600 mm

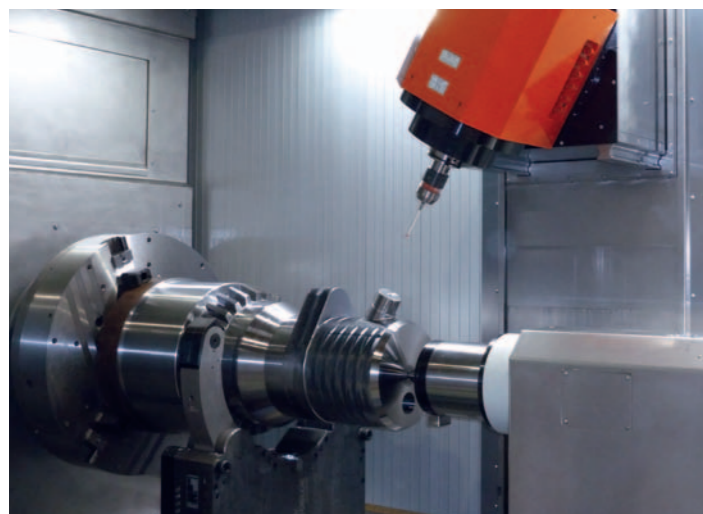

Tool measurement. The entire tool measurement is integrated in the process and guarantees high precision as well as measurements during the machining process.

Measuring Probes for High Productivity, Safe Production Processes and Easy Handling



The swivel-mounted, movable control panel and, as an alternative, the manual control panel ensure higher flexibility and maximum access to the work area.

Modular Solutions for Increased Productivity.

Optionally, different standardized milling solutions are available: HSK or Capto (PSC), with water-cooled milling spindle with a max. 6500 or 10000 rpm. Optimal power and torque for every type of machining is achieved by the precise coordination of mechanics and control. The Hyperturn 200 Powermill offers optimum conditions in terms of flexibility, set-up time reduction, stability and maximum productivity for the complete machining of large workpieces.

Power and torque diagram main spindle – counter Spindle

Main spindle and Counter Spindle. With performance data that make all machining possible without compromise. The EMCO spindle design has two servo motors that also act as C-axis. The motors operate in opposition, guaranteeing the balancing of the play and enabling the achievement of the power and torque as can be seen in the diagram above. The main spindle is also equipped with a special EMCO cooling system that optimizes the temperature stability and guarantees maximum precision with any length of machining.

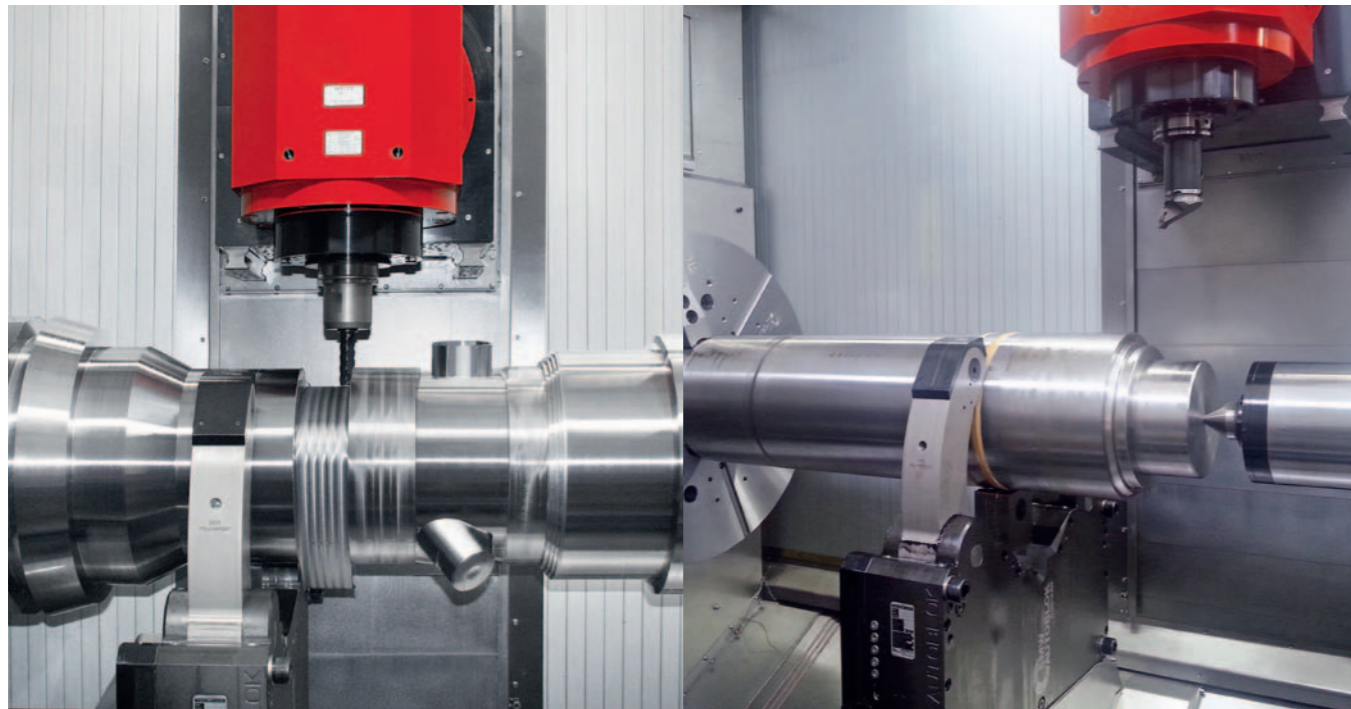
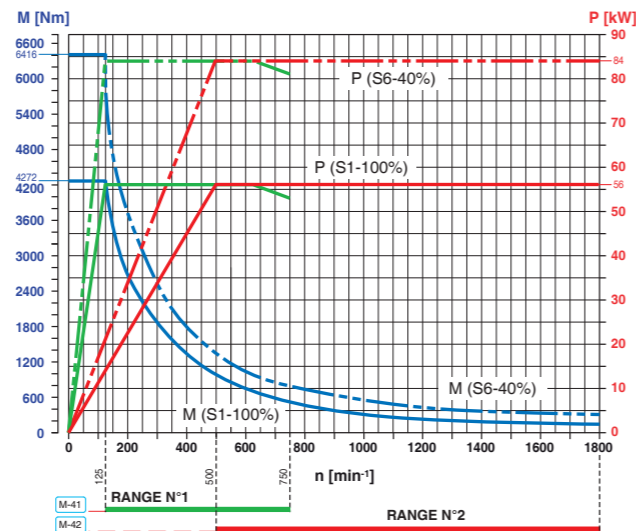

Power and torque diagramm standard milling head

Milling spindle. Ready for use in the standard version with 6500 rpm for all turning, drilling and milling operations and technologies. The water-cooled ISM (integrated spindle motor) is available up to 80 kW and 630 Nm torque and with the HSK-T 100 or PSC80 (Capto C8).

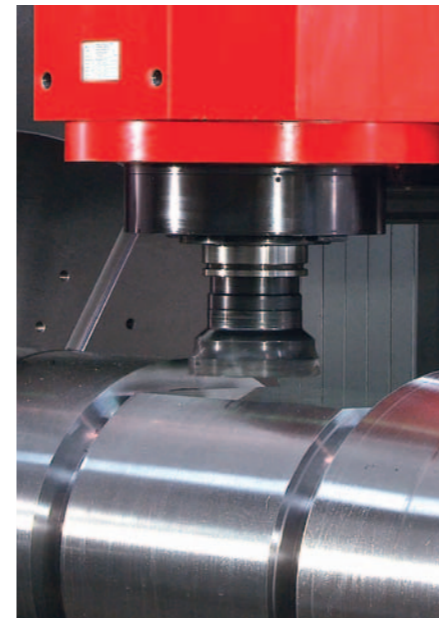
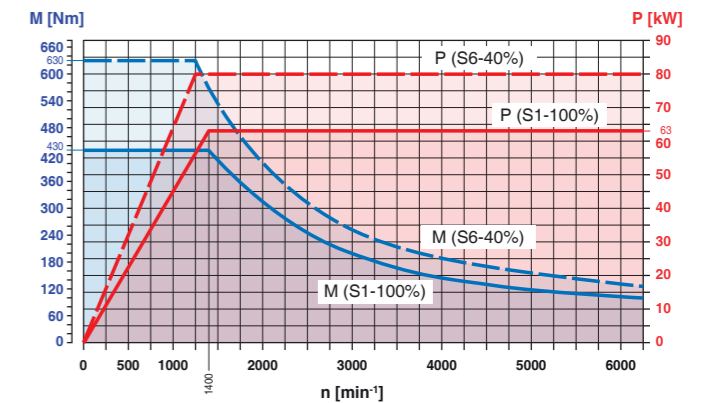

Power and torque diagramm high speed milling head

Milling spindle. Optional version with 10000 rpm. High speed for turning, drilling and milling operations, complex technologies usable for light alloys, aluminum, etc. The water-cooled ISM (integrated spindle motor) is available up to 80 kW and 340 Nm torque and with the HSK-T 100 or PSC80 (Capto C8).

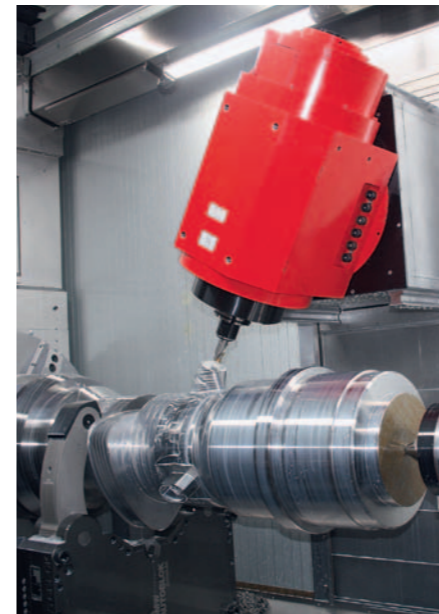
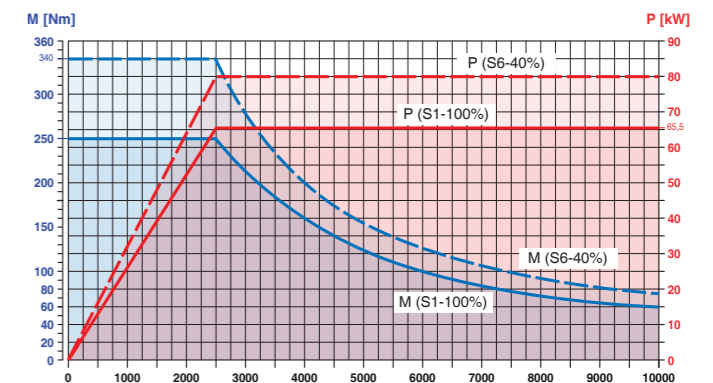

Your “Control Center” for
the entire production flow

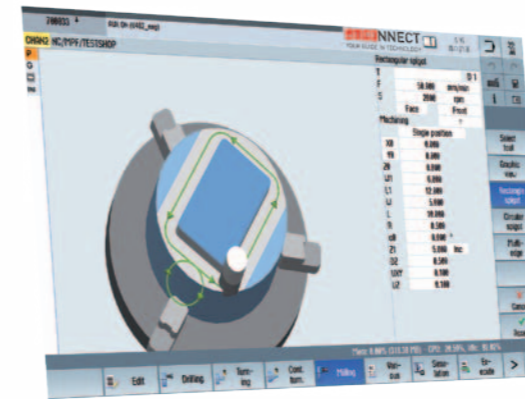

SINUMERIK - the Control and the Machine's Centerpiece

Thanks to the App Launcher operators may switch between the emcoNNECT Apps and the control at any time. All it takes to do so is a click on the emcoNNECT logo. To improve the work processes on the machine the control can, as shown in the picture, be operated in full screen mode or in interaction with practical apps (sidebar).

DASHBOARD – For a Quick Overview of the Machine Status

Clear and compact processing of all relevant machine and NC data depending on the configuration of the machine (number of tool systems, spindles, ...) and the active operating mode (JOG, MDA, AUTO). Know at a glance whether everything is OK or whether the machine operator will be required to interact.

MACHINE DATA – All Data related to Productivity at a Glance

Operating data collection to inform the user about the current production status and OEE (Overall Equipment Effectiveness) values full screen or sidebar.



emcoNNECT's hardware basis is a 22" industrial touch control panel combined with an industrial PC (IPC).

Highlights

- Direct interaction between EMCO Apps and the control
- Intuitive user interface optimized for touch control
- Range of available applications is continuously being expanded
- Customised and project-specific applications
- Optimized for the EMCO machine range
- emcoNNECT allows for easy and quick configuration and updating

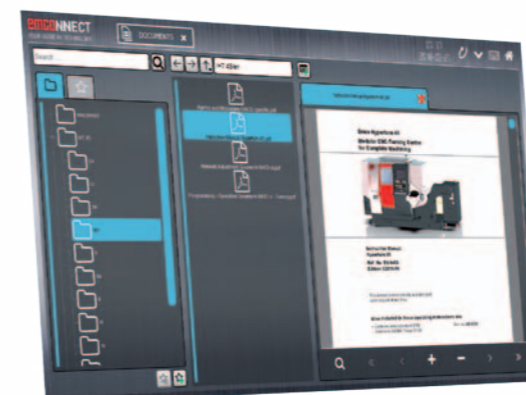

DOCUMENTS – A Digital and Expandable Document Collection Customised to Suit Your Individual Needs

To display PDF documents such as machine documentations, programming instructions, process descriptions ... Including favourites management - full screen or sidebar

Virtual Workflow. Real Benefits.

The Esprit CAM system offers high flexibility and process security, a comprehensive selection of machining cycles, maximum tool control, and cross-machine technology for your entire production facility. EMCO CPS Pilot provides a true 1:1 mapping of the real machine for defining and testing processes, optimising machining sequences and training new specialist workers.

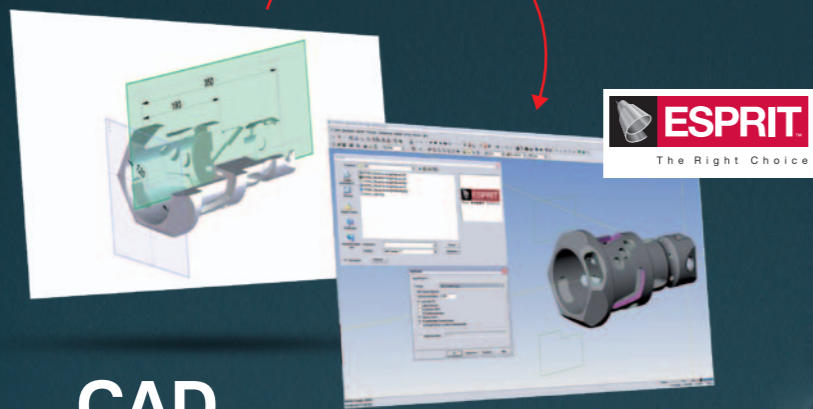

CAD

Direct CAD data import

- AutoCAD (DWG)
- Parasolid®
- Solid Edge®
- Solid Works®
- ACIS® (SAT)
- Optional interfaces:
CATIA®, Pro/ENGINEER®,
STEP, STL,...



CAM

- 2-22 axis turning
- 2-5 axis milling
- Multi-tasking of turning and milling
- 3D machine space simulation
- Certified post-processors

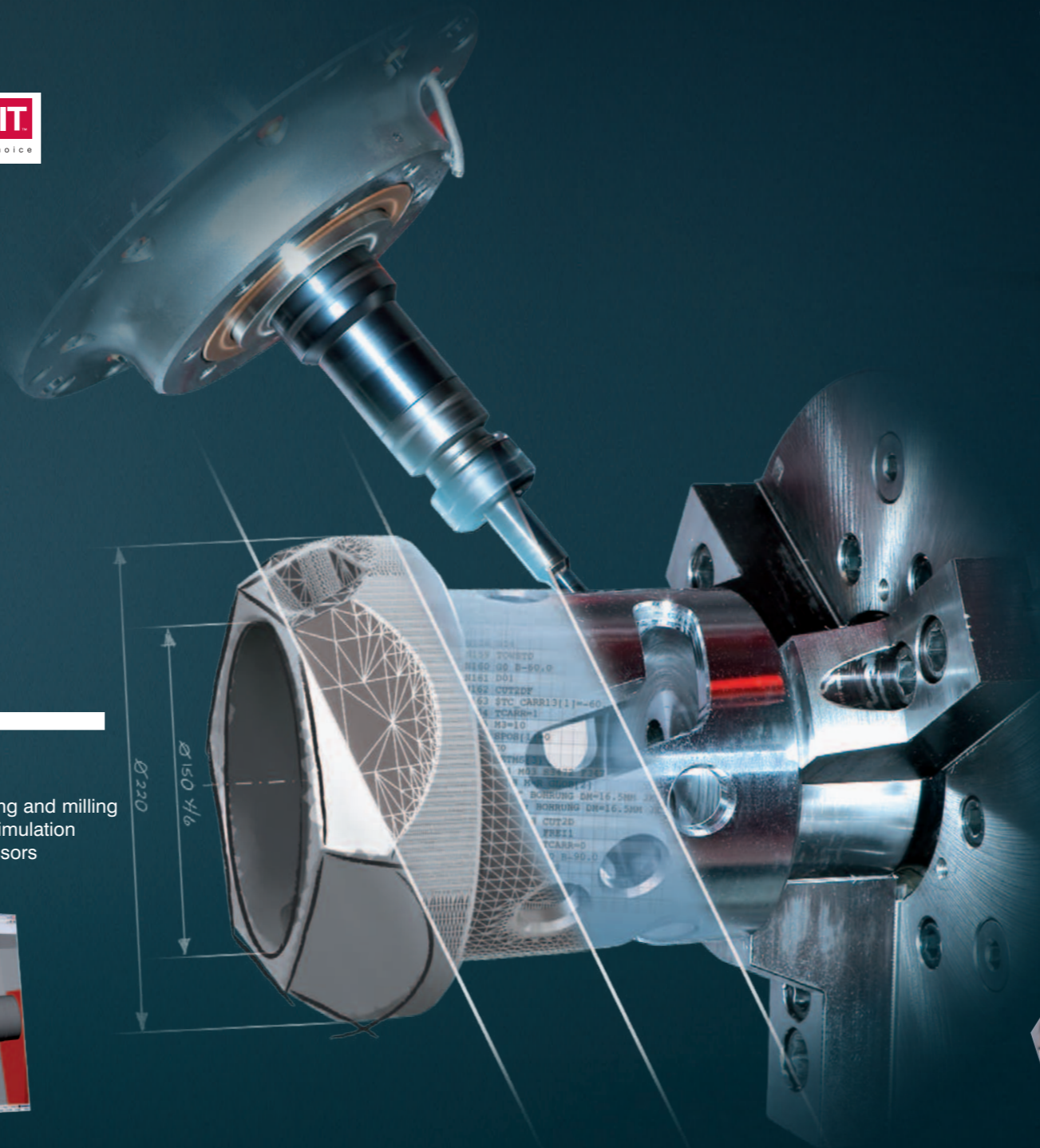
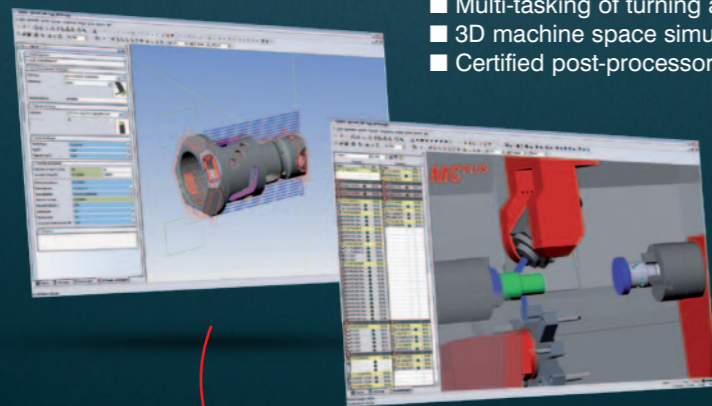

CPS

- 1:1 simulation with collision detection
- Direct connection to CAM ESPRIT
- Process optimization
- Reverse simulation of existing NC codes
- Reduction in scrap rates
- Training on the virtual machine
- Simulation of loading systems
(e.g. EMCO gantry loader)



Production

- Reduction in set-up costs
- Reduction in downtimes
- Reduction in repair costs
- Optimum machine utilization



Sinumerik 840D sl. Open, powerful, flexible.

The Sinumerik 840D sl with Operate user interface is ergonomically located at EMCO on the left of the work area and can be swivelled approx. 120° and - with the Hyperturn 200 - also be moved. Shopturn dialog programming, RJ45 and a 230 volt outlet on the side are included in the standard version as well as a robust OP19" touchscreen for industrial use.

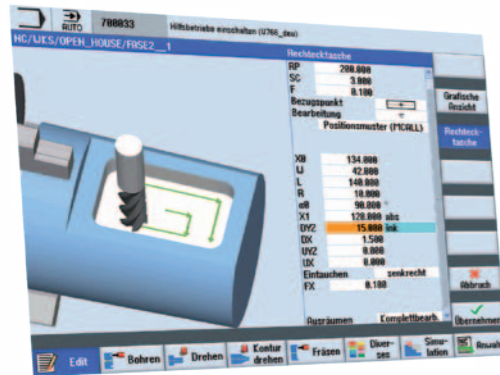

Shopturn-Shopmill / Machining cycles

The machine programming can be chosen completely freely from ISO to Shopturn. Complex workpieces require efficient production methods and innovative CNC solutions. The SINUMERIK 840D sl CNC equipment supports multi-technology equipment in the machining of workpieces in one setup and offers innovative functionality for this - even alternating between different technologies.

Machining simulation

3D simulation, simultaneous display during the turning and milling - with representation of detail and workpiece cutting. This achieves a significantly higher efficiency in production and all information is available on the machine.



Platz	MT	PL	Typ	Werkzeugname	Werkzeug - Funktionen	NC-Speicher	Einheits
1				UTENSILE_SGR05	Schleifer		Fräse
2				ERNSTECHE_R14	Schleifer		180-185
3				518 - Schleifer			
4				528 - Einstecher			
5				548 - Gehäusestahl			
6				558 - Platte			
7				568 - Drehbohrer			
8				588 - 3D-Fresstaster Drehen			
9				738 - Reibschlag			
10				128 - Schaftfräser			
11				148 - Planfräser			
12				158 - Scheibenfräser			
				208 - Spiralbohrer			
				248 - Gewindebohrer			
				Plattfräse			

Tool management: Simple and open operation through an integrated management tool for all tool types and data.

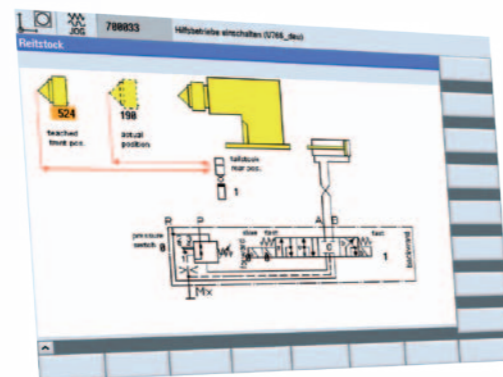

EMCO Diagnostics:

EMCO Diagnostics for rapid, easy analysis of the whole machine (for example: tailstock hydraulic scheme and quill position monitoring).

Quality Components

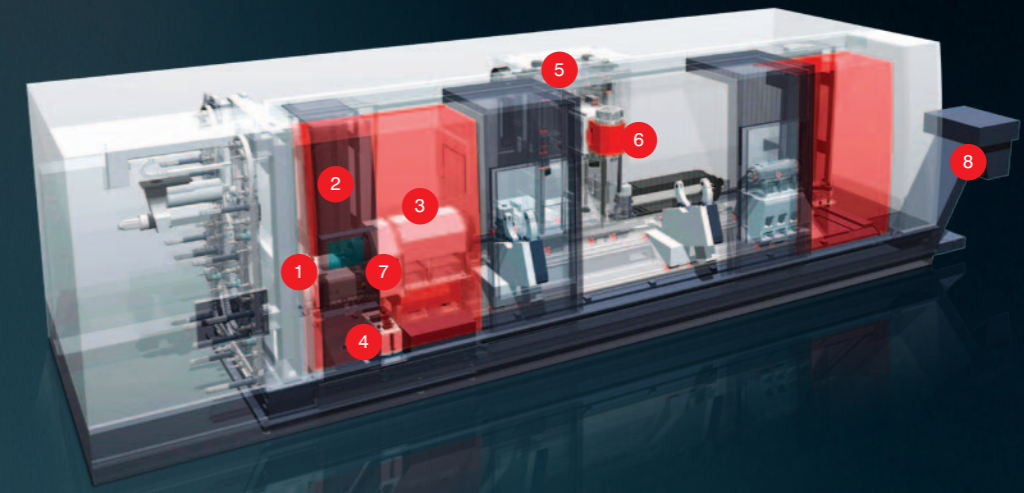

Clamping cylinder, chuck, steady rest

A hydraulically actuated clamping cylinder and clamping chucks guarantee accurate and secure clamping of the workpieces. The stroke control is realized by means of programmable sensors. The time-consuming adjustment of non-contact limit switches is eliminated.

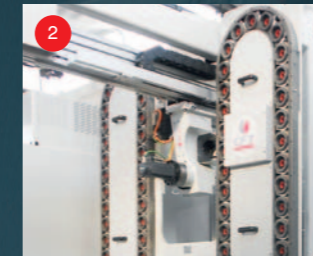

Tool magazine

The extensive machining capabilities require a wide variety of tools. Up to 200 tool positions, lengths up to 600 mm and tool weights of up to 30 kg are no problem for the fast tool changer with double gripper.

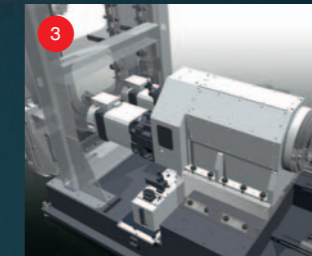

Spindle tooling

The design and manufacture of spindle tooling is one of the core competencies of EMCO. In the engineering the focus is on precision, robustness, high rigidity, precision concentricity and a longer service life.

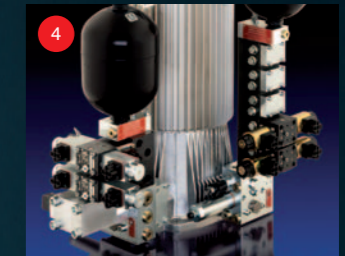

Hydraulic system

Compact size, quiet operation and high energy efficiency are among the advantages of the hydraulic aggregates used by EMCO. A tracking pressure switch saves time-consuming, manual adjustment of the pressures.

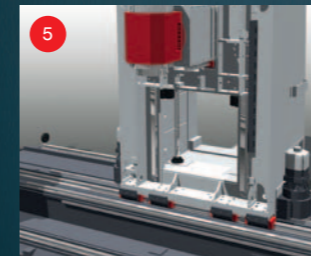

MMachine beds / Slides

In the alignment of the components, we place the emphasis on stability, good damping behavior, and a thermo-neutral construction. The high stability is achieved by a short power flow, thermal stability by symmetry and the damping by the choice of materials and interfaces.



Milling spindle / B-axis

The new ISM milling spindle and B-axis torque motor unit from Weiss Spindeltechnologie GmbH in stands out in particular for its high precision, as well as an extremely high torque and represents today's state of the art. The backlash-free milling drive allows not only turning, milling and drilling but also thread cutting without compensation chucks, gear hobbing as well as various special technologies. In combination with the CNC Sinumerik Sinamics control, the commissioning and complete monitoring of the spindle in the machine is significantly easier.



Ball screws, roller guides, rack drives, glass scale

High-precision and large-sized guide rails, ball screws and rack drives with optimal preloading provide the basis for the machining of precision parts. High feed force and heavy and accurate machining can be performed easily.



Chip conveyor, paper tape filter, coolant pump

Hinged belt conveyors can be used flexibly and provide for the safe removal of the chips. An overload coupling with monitoring prevents damage on improper use, the 1400 l paper tape filter specifically for difficult to machine materials require, in addition to a high pressure, a very high coolant flow rate. Low-maintenance submersible pumps for pressures up to 80 bar and flow rates up to 25 l/min offer optimal conditions for the machining and ensure a reliable chip transport.

Installation plans

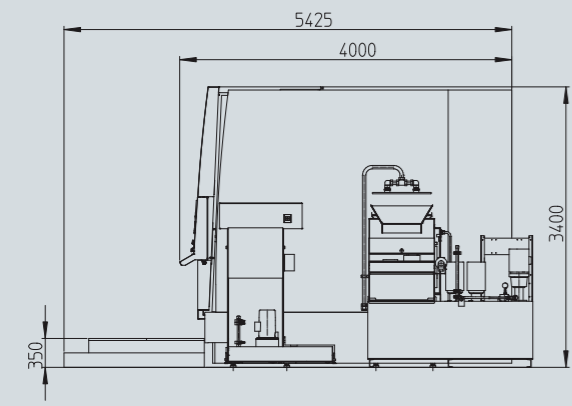
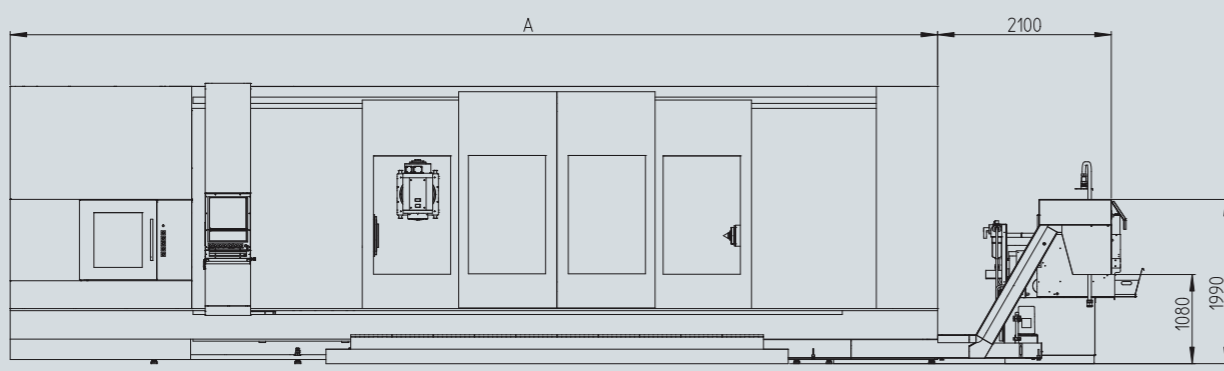
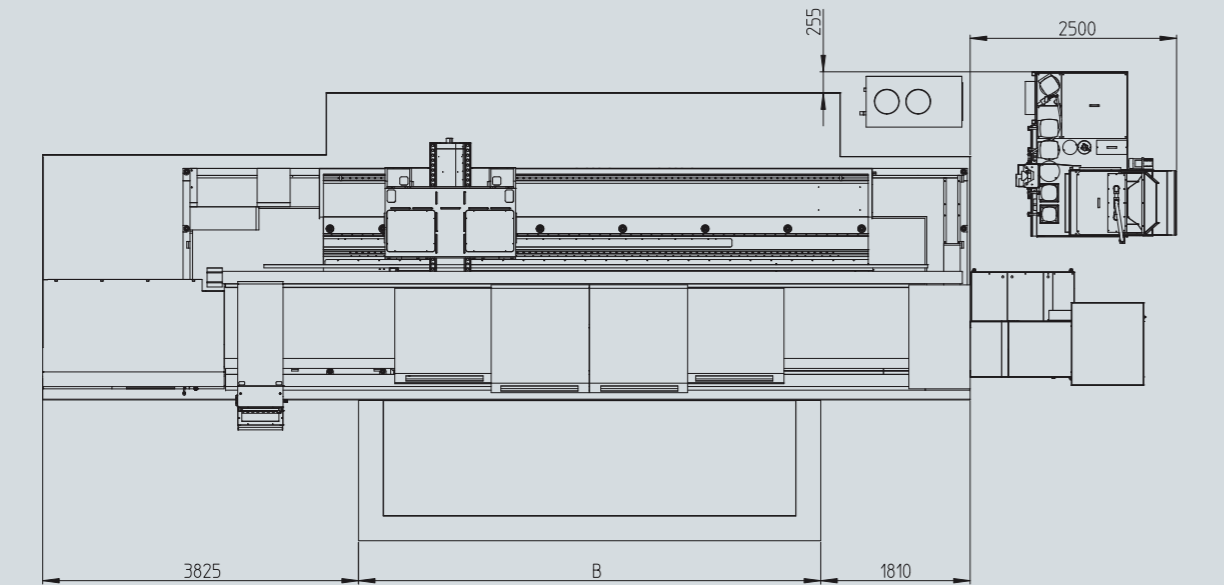

MACHINE LENGTH				
	3000	4000	5000	6000
A	10235	11235	12235	13235
B	4600	5600	6600	7600

Indications in millimetres

Work area

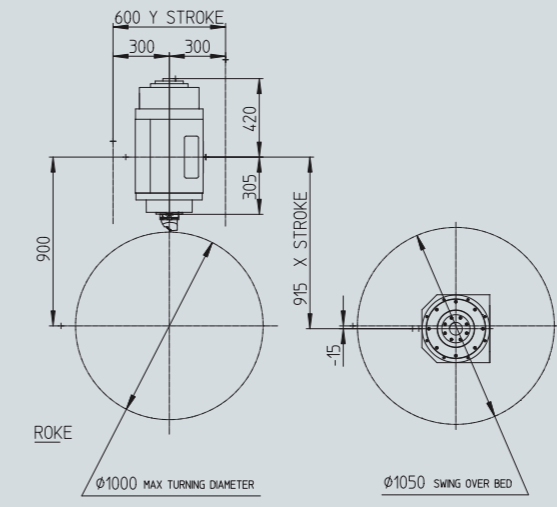
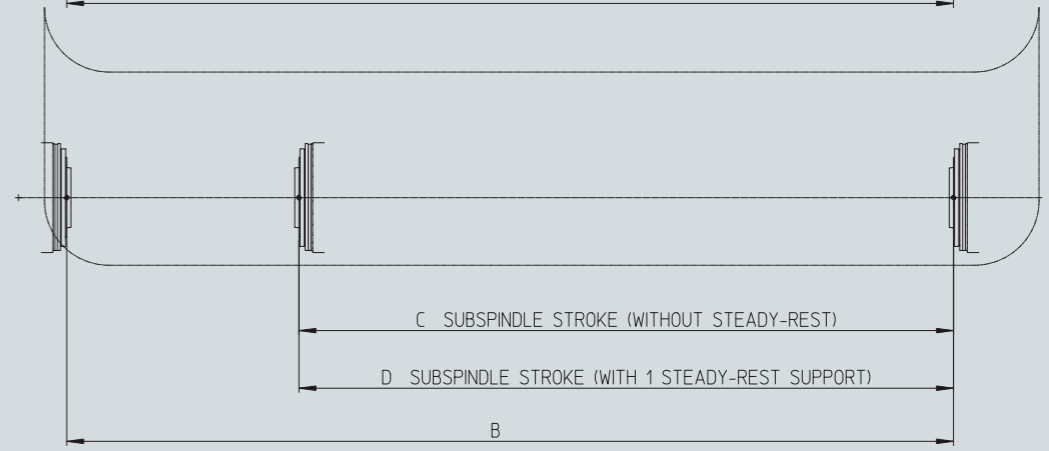
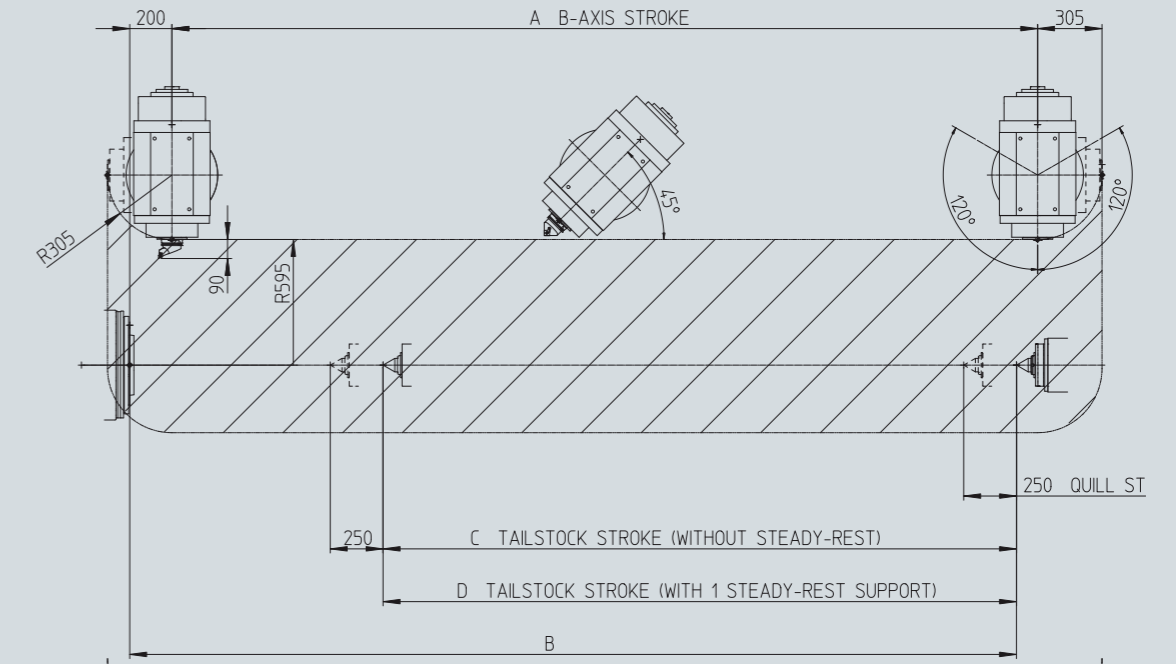

MACHINE LENGTH				
	3000	4000	5000	6000
A	3100	4100	5100	6100
B	3200	4200	5200	6200
C	3000	4000	/	/
D	2100	3100	4100	5100

Indications in millimetres



Machine configuration for all models of the Hyperturn 200:

- A2-15" spindle with integrated C axis
- MT6 tail-stock
- Y axis
- HSK 100T 6500 rpm electro-spindle
- Spindle brake (2x for S version)
- Tailstock function of the counter spindle
- Programmable clamping pressure, stroke monitoring
- Programmable quill
- Tool magazine with 50 positions
- Siemens 840D solution line numerical control system
- Pneumatic system
- Paper filtering system with paper filter pumps
40 / 20 / 14 / 7 / 7 bar
- Hydraulic system
- Cooling system for millingspindle, main spindle,
counter spindle (S version) and hydraulic oil
- Centralized lubrication system
- Internal machine lighting
- Linear roller guides
- Absolute optical rows on X, Y, Z, axes
- Chips conveyor belt
- Piece washing gun
- Alarm state indicator lamp
- Electrical cabinet air conditioning unit
- Front panel automatic opening
- Platform
- Foot controls for clamping means as well as quill
(2x for S version)
- Machine fastening elements
- User manual

Optional:

- Electro spindle 6500 rpm PSC80
- Electro spindle 10000 rpm HSK 100T / PSC80
- XL tool storage with 200 positions
- Additional magazine for special tools
- Autom. tool measuring + laser
- Piece measurement probe
- Program. steady rest 1 diameter 650 mm
- Boring bar
- More steady rests possible
- Steady rest 1
- Electrostatic extractor
- 80 bar high pressure pump
- Memory extension / Siemens 840D sl
- Emco tool load monitoring
- Emco netservice / siemens
- Gear hobbing – Siemens 840D sl
- 5-Axis simultaneous milling
- Emco CPS-PILO T
- Esprit programming System
- EMCO Technologie-Zyklen
- Emco Skyving
- 5-Achsen-Interpolation
- Netservice
- Auriga

If required, EMCO's technology department can develop and offer copious options as well as customised solutions.

HYPERTURN 200 Powermill Technical data

Workspace

Swing diameter over the bed	1050 mm
Max. turning diameter	1000 mm
Distance between spindle and center (MK 6)	3200 / 4200 / 5200 / 6200 mm
Stroke X axis	915 mm
Stroke Z axis	3100 / 4100 / 5100 / 6100 mm
Stroke Y axis	+/- 300 mm

Main spindle and counter spindle (optional)

Spindle connection (DIN 55026)	A2-15"
Power chuck diameter	500 / 630 / 800 mm
Max. spindle speed (with gear)	1800 rpm
Max. power	84 kW
Max. torque	6410 Nm
Max. weight including feed	1500 kg
Max. weight between the centers including feed	6000 kg

Tailstock with quill

Travel without steady rest	3000 / 4000 / 5000 / 6000 mm
Quill travel	250 mm
Quill diameter	200 mm
Max. thrust	40000 N
Tailstock travel speed	15 m/min
Bore tape dimension (intergrate bearing)	MT 6

X, Z, Y-axis

Rapid traverse speed X/Y/Z	30 / 30 / 30 m/min
Feed force X	30000 N
Feed force Z	30000 N
Feed force Y	20000 N
Diameter X-axis ball screw x pitch (2 time)	63 x 20 mm

C-axis of main spindle

Angular resolution	0,001°
Max. torque	5000 Nm
Spindle brake - holding torque	6000 Nm
Max. speed	100 rpm

Milling spindle / B-axis

Tool system	HSK-T 100 / PSC80 (Capto C8)
Max. drive power	80 kW
Max. spindle-speed (opt.)	6500 (10000) U/min
Max. torque (opt.)	630 (340) Nm
B-axis stroke	240°
Rapid traverse speed, B-axes	50 U/min
Max. torque with index B-axis	15000 Nm
Max. torque with interpolation B-axis	2130 Nm
Kleinst Indexierung	2,5°
Kleinst Schrittweite B-Achse	0,001°

Tool magazine

Tool magazine positions	50 – 100 – 200
Max. tool length	600 mm (opt. 3 x 1000 mm)
Max. tool diameter	120 mm
Max. turning tool weight	25 kg

Coolant system

Coolant pressure	40 / 14 bar
Flow rate at 20 bar	30 l
Filter system	40 Micron
Coolant tank capacity	1400 l

Power consumption

Power rating	125 kVA
Compressed air connection	6 bar

Dimensions

Height above floor	1550 mm
Total length with chip conveyor and cooling system	12400 / 13400 14400 / 15400 mm
Height	3400 mm
Width / with control panel	4000 mm
Weight (depending on the type and accessories)	30000 – 45000 kg
Transport Dimensions L x H x W	10400 / 11400 / 12400 / 13400 x 3400 x 3100 mm

