

EMCO

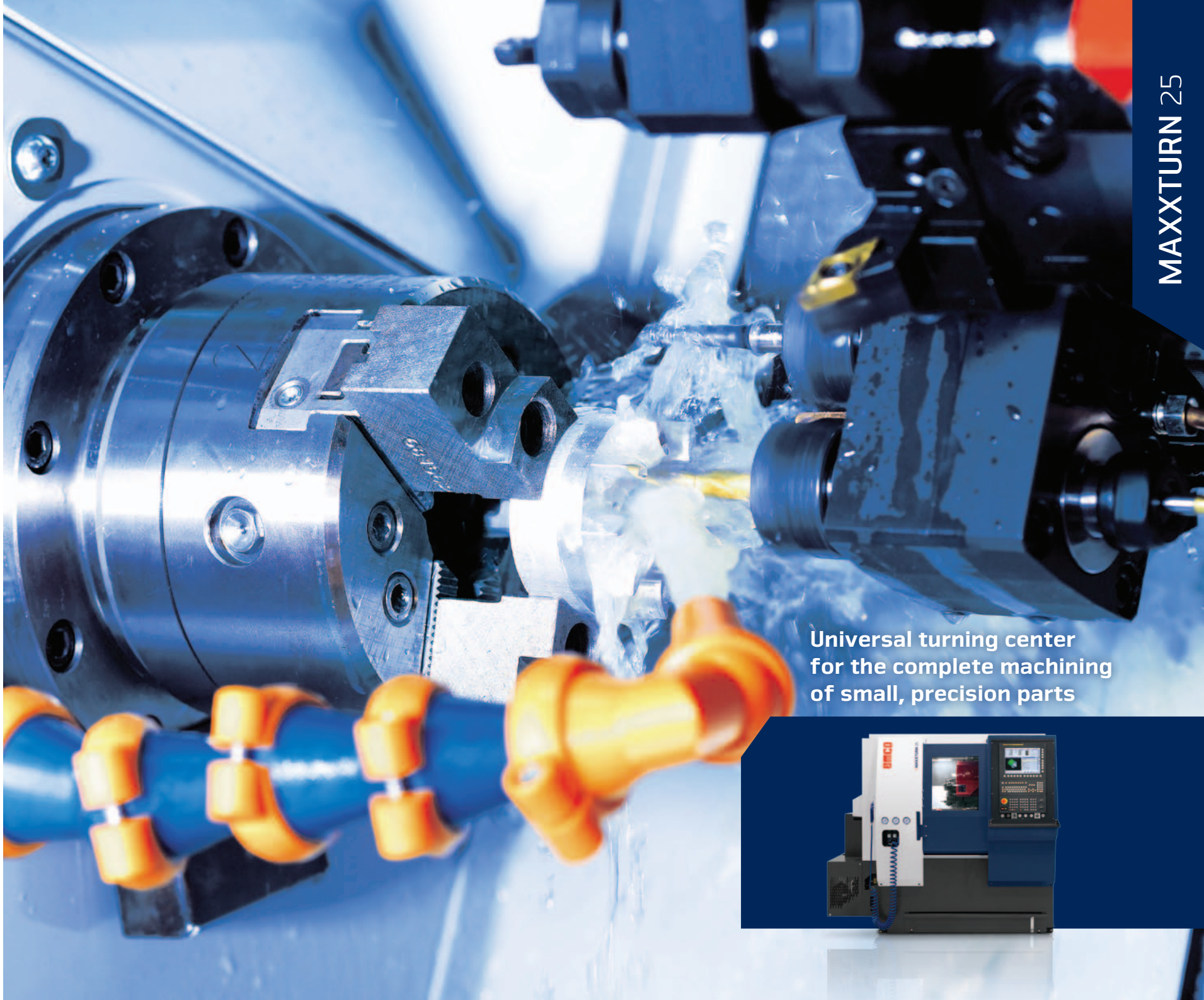

Universal turning center
for the complete machining
of small, precision parts



MAXXTURN 25

/ BIG PERFORMANCE FOR SMALL PARTS

The EMCO MAXXTURN 25. The perfect solution for the complete machining of small parts. Compact, economical and high precision. Suitable for bar parts up to a diameter of 25 mm and chucked parts up to Ø 85 mm. Fitted with a counter spindle, Y axis and driven tools. The tool turret has space for 12 VDI16 tool holders. The 36 indexing positions mean the number of tools can be increased to 42 cutting edges. The MAXXTURN 25 comes with a Siemens or Fanuc control including ShopTurn or ManualGuide conversational programming system.



Tooth implant
(Titanium)

1 WORK AREA

- / Spacious
- / Free chip flow
- / Easy access

2 COMPACT MACHINE DESIGN

- / Requiring minimal floor space

3 HYDRAULIC

- / Front-operated

4 COOLANT RESERVOIR

- / Large coolant container
- / Mounted on wheels
- / Easy to clean
- / Highest thermostability



Maschine mit optionaler Ausstattung.

5 CONTROL

- / Ergonomically placed
- / SINUMERIK 828D incl. Shop Turn and 15" Touch-Display
- / FANUC OiTF incl. Manual Guide i and 15" LCD color monitor
- / Includes Ethernet and USB interface
- / Optionally with EMCO Remote Support

6 SHELF

- / Space for measuring devices and operating tools
- / Optional for the Sinumerik PC keyboard

7 MACHINE COVER

- / Total protection from chips
- / 100% coolant retention
- / Large safety-glass window in door
- / Clear view into the workspace
- / Built-in buttons for operator convenience

8 COOLANT TANK

- / 14 bar high-pressure pump
- / Increased coolant volume

STRUCTURE

Designed on the basis of FEM analyses, the MAXXTURN 25 meets the high demands of modern machining in an ideal manner. Maintenance-free roller guides in all linear axes ensure high stability and precision. Another advantage is offered by minimum lubricant consumption teamed with long tool lives. When it comes to shaft processing, the machine can be equipped with tailstock or counter-spindle. The counter-spindle offers the advantage of being able to finish the workpiece completely on all sides. This also includes drilling and milling operations on the rear side.

1 MAIN SPINDLE

- / High drive performance
- / Compact, thermostable construction
- / Large range of speeds (0 – 8000 rpm)
- / Spindle nose \varnothing 70 h5
- / Bar capacity diameter 25.4 mm
- / C axis (0.001° resolution)
- / Including spindle brake for milling

2 MACHINE BED

- / Rigid cast iron body
- / Torsion-proof due to heavily ribbing
- / Tension-free and thermally separated bolted to the machine stand at 3 points

3 LINEAR GUIDE WAYS

- / Pre-stressed in all linear axis
- / Free of play in all force directions
- / High rapid-motion speeds
- / No wear
- / Minimal lubrication

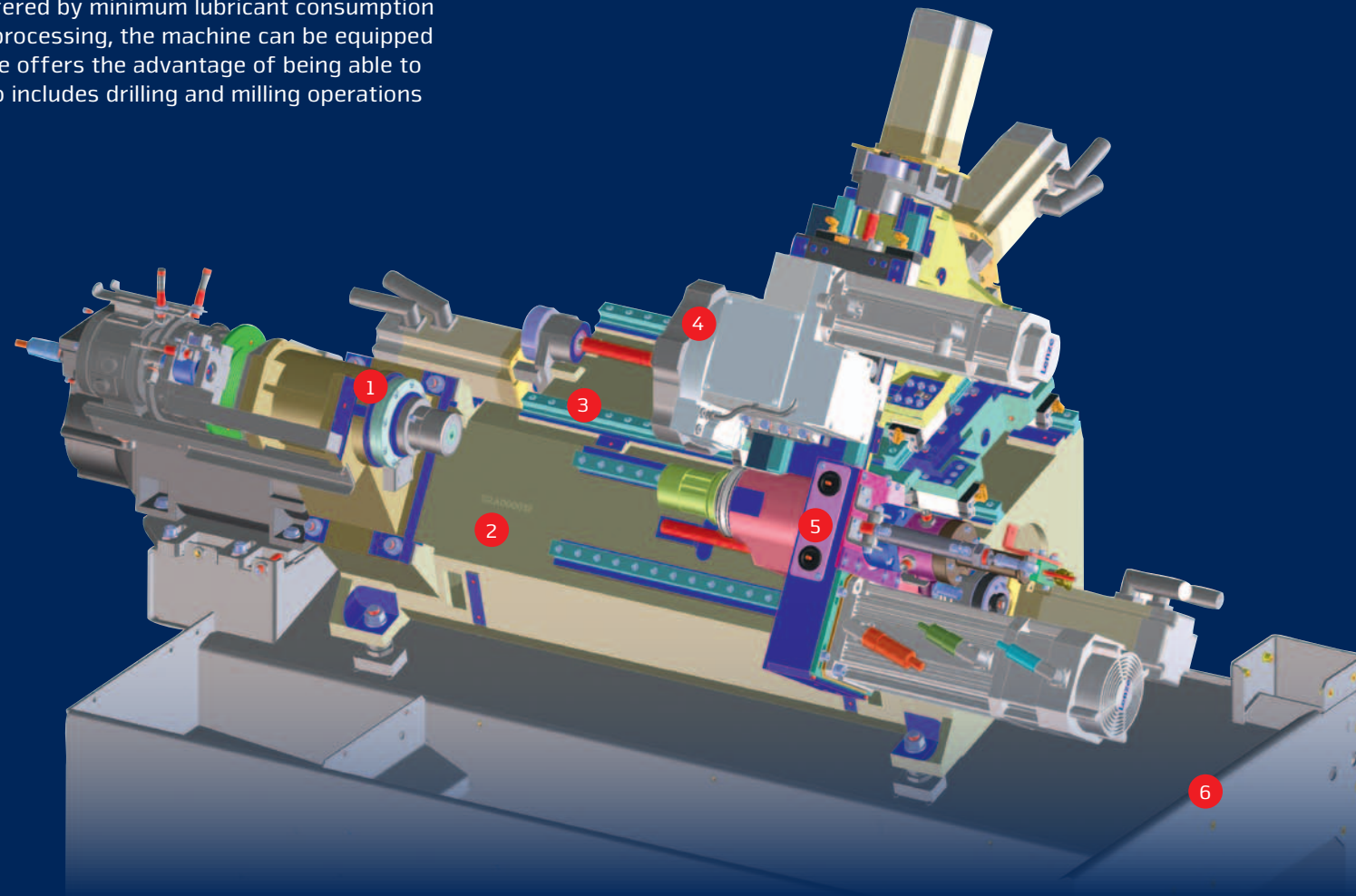

4 TOOL TURRET

- / 12 position VDI 16 turret disc
- / 6 driven tool stations
- / 36 position indexing (10° resolution)
- / Swivel speed adjustable with override

5 COUNTER SPINDLE

- / Space-saving integrated
- / Large range of speeds (0 – 8000 rpm)
- / Parts ejector flooded with coolant
- / C axis (0.001° resolution)
- / Spindle nose \varnothing 70 h5

6 MACHINE BASE

- / Compact welded-steel construction
- / Large coolant tank easy to clean
- / No levelling needed
- / 100% sealed against coolant leaks

Performance and Torque

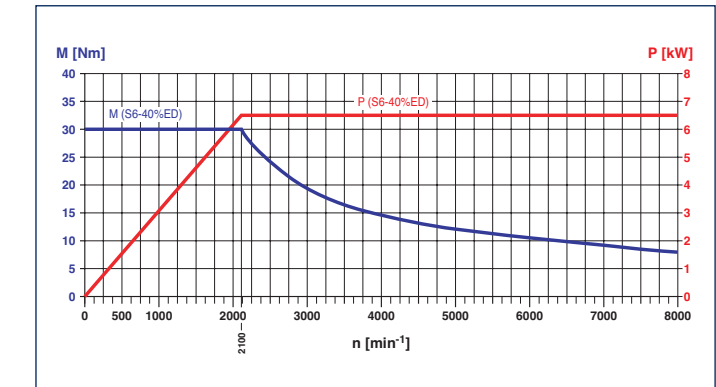

Motor characteristics for the main spindle

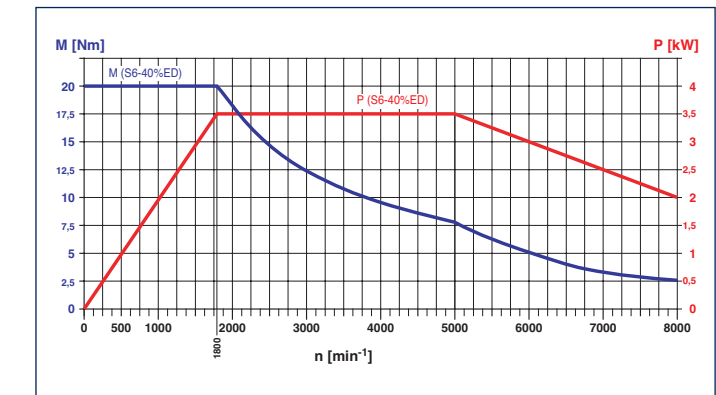

Motor characteristics for the counter spindle

TECHNICAL HIGHLIGHTS

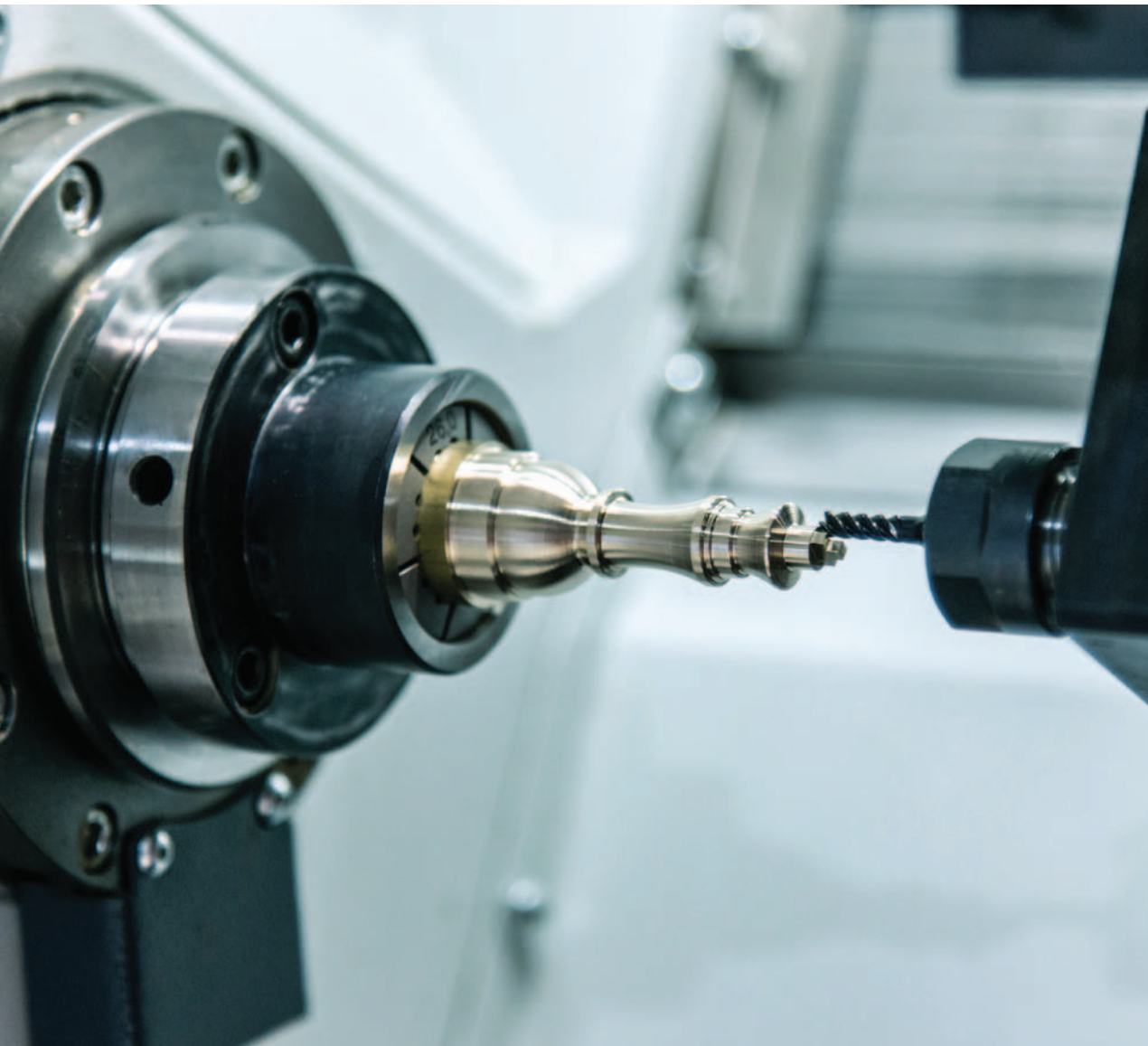

MAIN SPINDLE

Being mounted on pre-stressed high-precision bearings, the main spindle can reach speeds ranging from 0–8000 rpm, making the production of small parts extremely economical and exact. The MAXXTURN 25 has a hydraulically operated hollow clamping cylinder with 25.4 mm bar clearance as standard equipment. A C axis with holding brake is also a standard fitting for milling operations. Resolution: 0.001°.

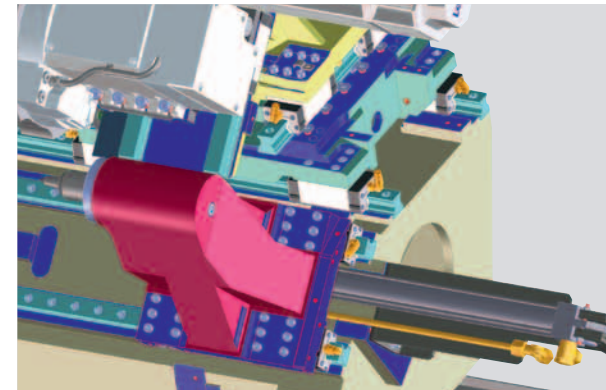

TAILSTOCK

The MAXXTURN 25 MY is also available in a tailstock version. The tailstock is set up on the linear roller slide and can be automatically positioned within a range of 360 mm. The live centre is integrated into the body of the tailstock and ensures a maximum of precision and stability. It is controlled using M functions.

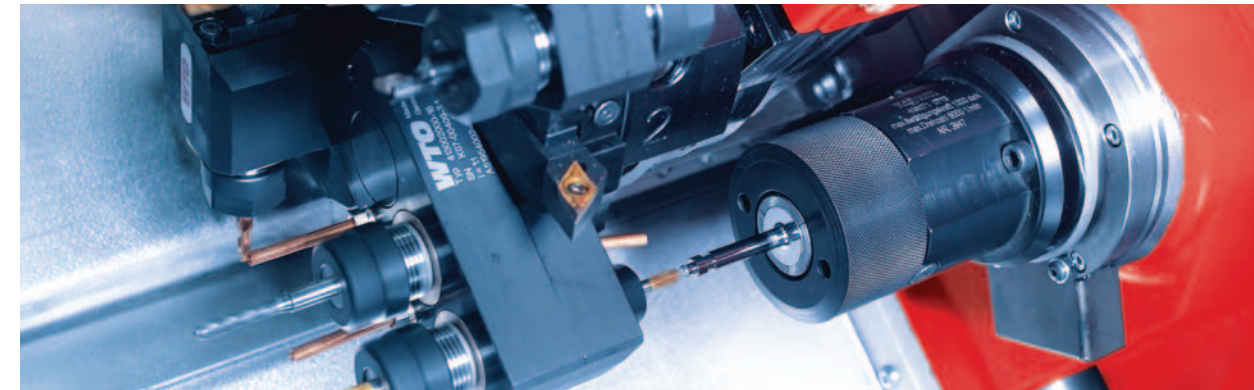

COUNTER SPINDLE

The machine has an extremely compact counter spindle for machining the reverse side. Mounted on guide rails, it can be positioned at 30 m/min. The parts are taken from the main spindle and completed in one process. Speeds ranging from 0–8000 rpm mean the best possible prerequisites for turning and drilling. The counter spindle can also be positioned for light milling and drilling operations.

HIGHLIGHTS

- / Large speed range
- / Counter spindle for complete machining
- / Driven tool positions
- / Stable Y axis
- / High rapid-motion speeds
- / Best machining quality
- / Compact machine construction
- / Made in the Heart of Europe

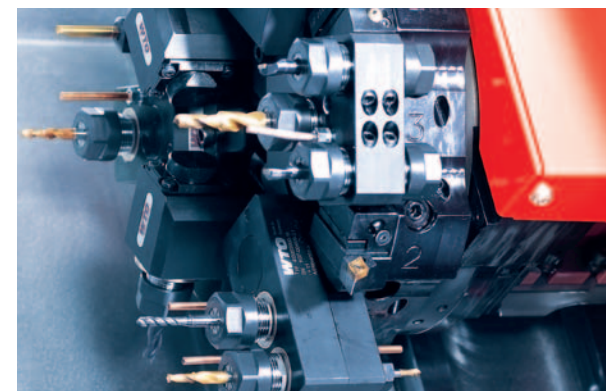

TOOL TURRET

Fast, servo turret with 12 VDI 16 position holes. It can be indexed up to 36 positions to increase the number of tools. This means up to 42 tools can be integrated when using multi-tool holders. The swivelling can be slowed or even stopped to simplify running-in the machine.

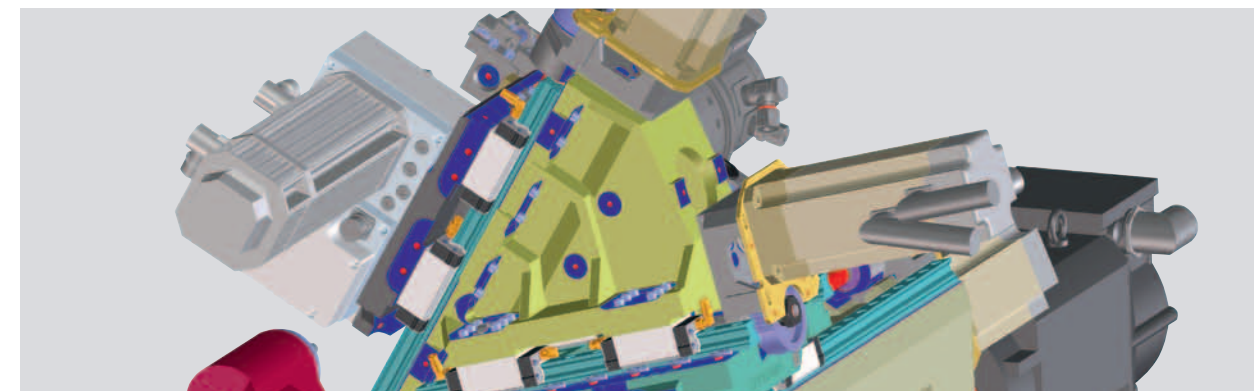

Y AXIS

The Y axis is integrated into the basic machine structure and stands at 45° to the X axis. Extremely short projections form the basis for solid turning and drilling operations, as well as milling operations without interference contour.



/ Ing. Johann Brisker
Brisker GmbH

"All EMCO turning machines are automated with short bar or bar loaders, which frees up employees for other tasks and, as a consequence, increases productivity."

/ The EMCO short bar loaders. Universal and powerful.



SHORT AND TO THE POINT.

The EMCO SL1200 is the perfect solution for automatic feeding and loading of cut-to-length bars. The key advantages are a small footprint and rapid loading times resulting from shorter strokes.

The technology. The SL1200 can be used immediately as a "plug-and-play" solution. Their extremely small footprint enables processes to be automated even if space is tight. Apart from complying with the latest safety requirements, it is easy to operate and moveable

for service purposes. Besides, it can comfortably be incorporated into the production process using the machine control's programme input masks. Minimum setup efforts are required when switching over to other bar diameters.

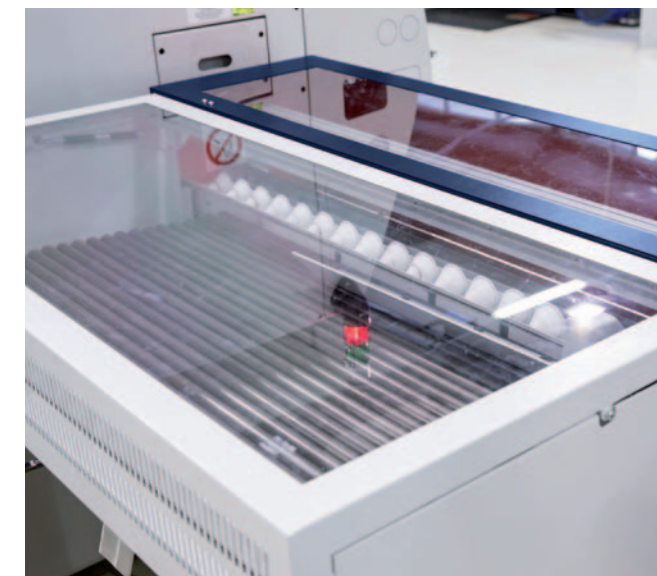

EMCO SL1200

Space-saving and cost-effective bar loading magazine. Operation and programming could not be easier. May also be used for loading single items through the lathe's main spindle.



SPINDLE EXTENSION FOR SHORT BAR LOADER

The spindle extension can be offered for processing cut-to-length material bars up to a length of 800 mm. The cut-to-length bar material can then be automatically fed into the SL1200.

THE BENEFITS

- / Small footprint
- / Easy to use
- / Short feed times
- / Fast, straightforward changeover
- / Option to load individual workpieces
- / Central diameter adjustment
- / The loader operates without oil
- / Ergonomic EMCO design

Technical data	SL1200
Bar diameter	Ø 8 – 95 mm
Max. bar length	1200 mm
Min. bar length	150 mm
Max. bar weight	45 kg
Material storage length	approx. 560 mm
Feed rate	0 – 60 m/min
Bar change time	approx. 15 sec.
Dimensions (L x W)	1700 x 1250 mm
Weight	approx. 500 kg

OPTIONS

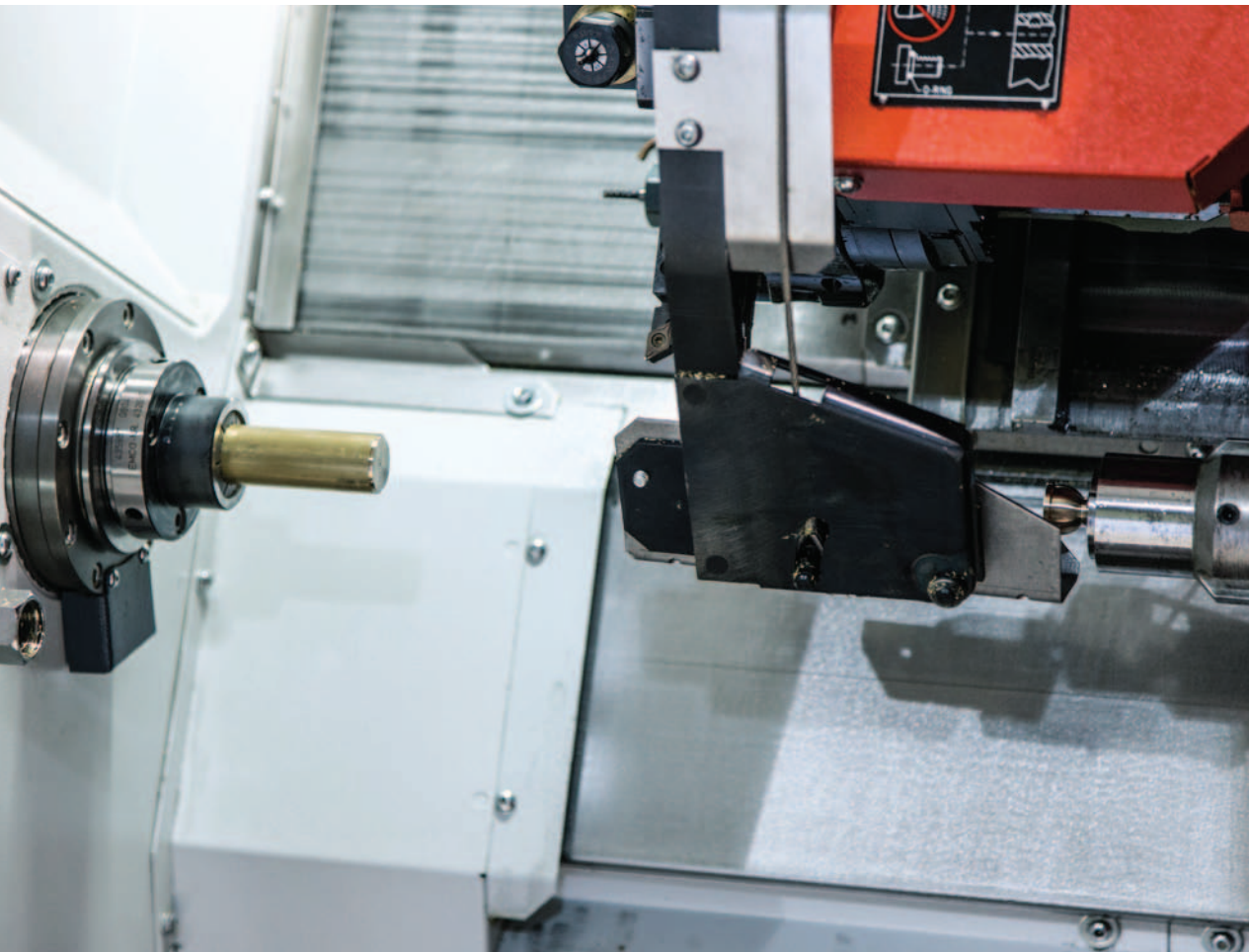

WORKING AREA WITH SWIVELLED IN PART-CATCHER

The generously sized work area provides space for a large number of tools on the tool turret and ensures a continuous chip flow even in unmanned production. After the parts have been transferred from the main spindle, the workpiece can be completely machined on the counter spindle and then unloaded with the parts catcher.



FINISHED PART CONVEYOR

The finished-part pick-up device puts the parts on an accumulating conveyor. A discontinuous belt ensures that the often very complex parts do not fall onto each other.



CLEANING NOZZLE

For cleaning the clamping devices, the covers and the entire work area. This option includes a cleaning nozzle with flow and jet adjustment as well as a solenoid valve, a key switch and a spiral hose.

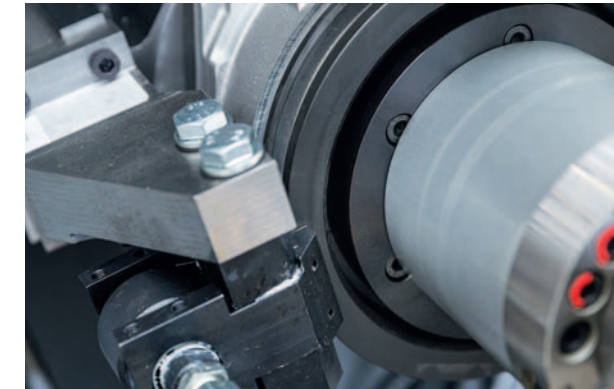

HOLDING BRAKE AT THE MAIN SPINDLE

For drilling and milling operations, the respective spindle is always positioned via the C axis. In addition, the main spindle can be clamped for demanding machining operations.

STATISTIK	Minimum:	Maximum:	Durchschnitt:	Messauftragsnr.:	
X	aktuell	4.11 120%	8.60 000%	8.97 121%	Bruch Verschl:
	letzter	299.99 99%	0.00 000%	18.40 517%	min. 50% 00%
	gelernt	3.21 0%	8.57 0%	3.61 0%	max. 150% 120%
Z	aktuell	0.47 47%	1.50 93%	0.93 88%	Bruch Verschl:
	letzter	299.99 00%	0.00 110%	4.59 417%	min. 50% 00%
	gelernt	0.99 0%	1.00 0%	1.10 0%	max. 150% 120%
Y	aktuell	9.70 70%	5.47 89%	4.07 70%	Bruch Verschl:
	letzter	299.99 40%	0.00 99%	0.60 10%	min. 50% 00%
	gelernt	5.29 0%	6.69 0%	6.89 0%	max. 150% 120%
C	aktuell	0.19 100%	20.62 52%	12.90 89%	Bruch Verschl:
	letzter	299.99 1%	0.00 260%	37.50 140%	min. 50% 00%
	gelernt	7.60 0%	39.87 0%	25.38 0%	max. 150% 120%

TOOL BREAK MONITORING

The tool status is monitored by evaluating the load on the various axis drive motors. Excessive loads point to wear or broken tools. Too little load means a tool is missing.

TOOL HOLDERS

For the complete processing of small complex components, a large number of stationary and driven tool holders are available. By using multiple tool holders, the number of tools on the turret can be increased considerably.



Double face and O.D. turning holder M4-VDI16 (S2Z 810)



Angular milling holder 90° VDI16 (S2Z 440)



Double face and O.D. turning holder M4-VDI16 (S2Z 820)



Offset axial milling holder VDI16 (S2Z 420)



Quintuple axial tool holder VDI16/ER16 (S2Z 430)



3Triple axial milling holder VDI16 (S2Z 410)

MACHINE LAYOUT

Maxxturn 25 with SL1200 and Chip Conveyor

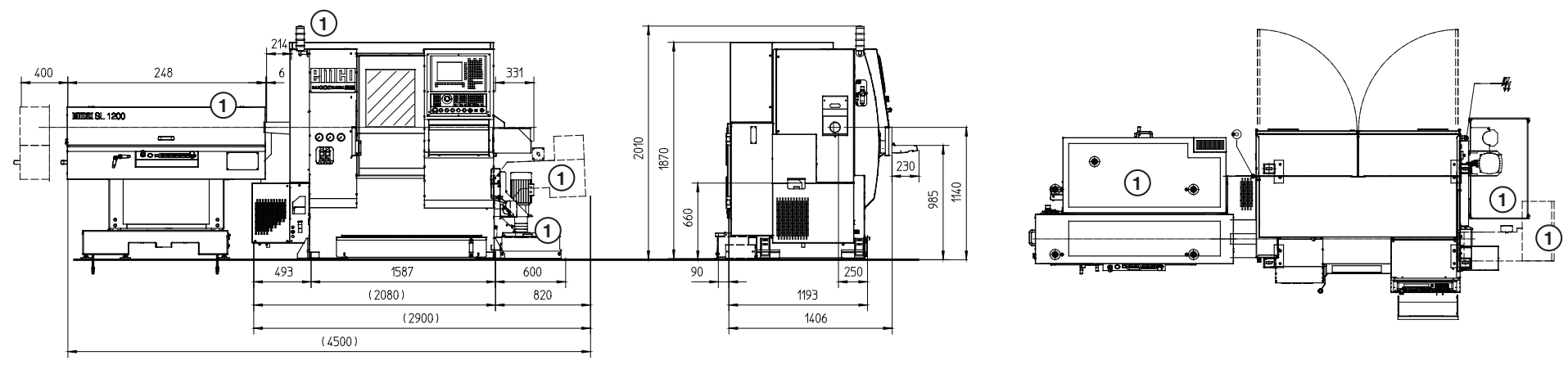

Details in millimeters

WORK AREA

Maxxturn 25 with counter spindle

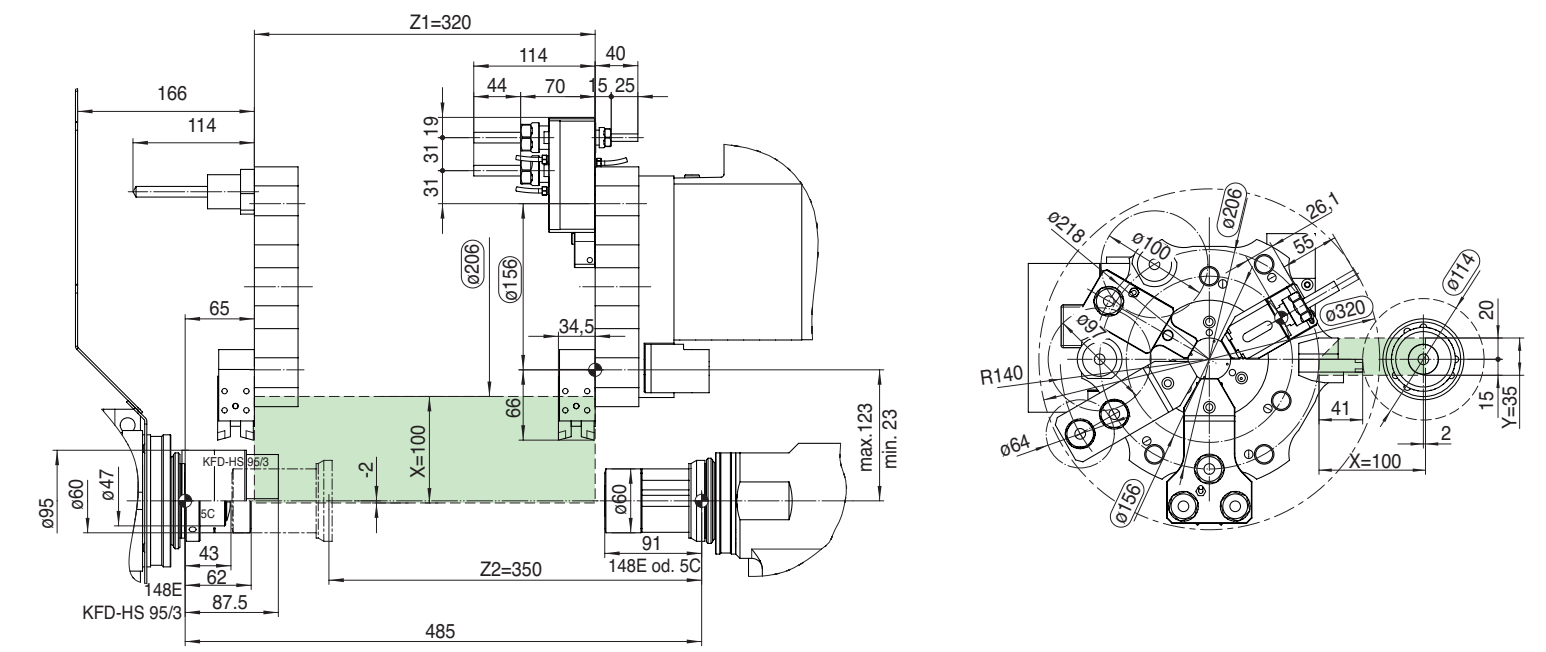

Details in millimeters

WORK AREA

Maxxturn 25
with tailstock

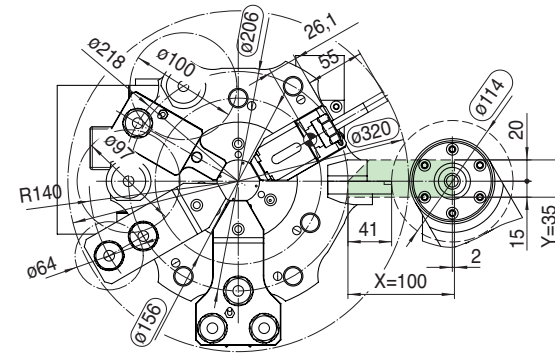
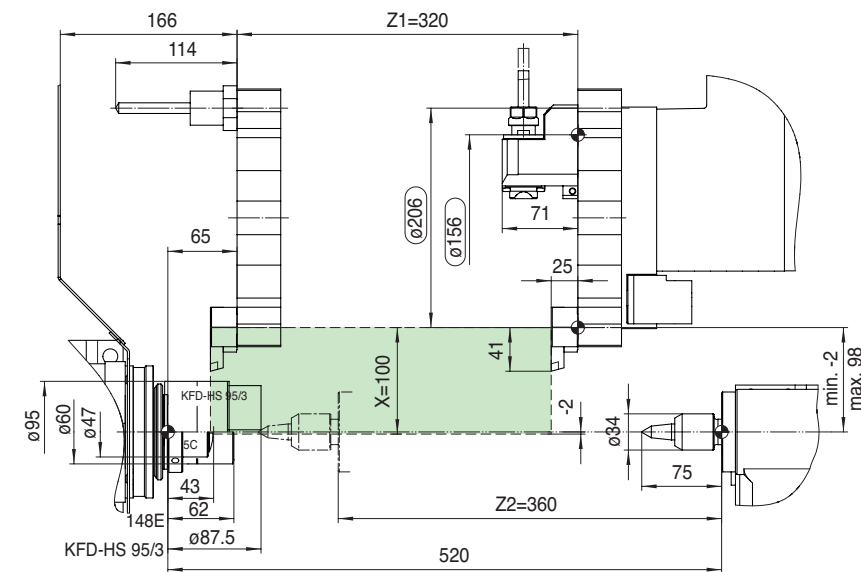

Details in millimeters

Technical data

Work area

Swing over bed	Ø 325 mm
Swing over cross slide	Ø 150 mm
Main spindle / counter spindle distance	485 mm
Maximum turning diameter	Ø 114 mm
Maximum part length	315 mm
Maximum bar diameter	Ø 25,4 mm

Travel

Travel in X	100 mm
Travel in Z	320 mm
Travel in Y	+20 / -15 mm
Travel in Z2	350 mm

Main spindle

Speed range	0 – 8000 rpm
Torque at spindle	30 Nm
Spindle nose	70 h5
Spindle bearing	Ø 60 mm
Spindle bore hole	Ø 33 mm

Counter spindle

Speed range	0 – 8000 rpm
Torque at spindle	20 Nm
Spindle nose	70 h5
Spindle bearing	Ø 45 mm

C axis

Resolution	0,001°
Rapid motion speed	1000 rpm
Spindle indexing	0,01°

Drive power

Main spindle	6,5 kW
Counter spindle	3,5 kW

Tool turret

Number of tool positions	12
Number of indexing positions	36
VDI shaft (DIN 69880)	VDI16
Tool cross-section for square tools	12 x 12 mm
Shaft diameter for boring bars	16 mm
Turret indexing time	0,2 Sec

Driven tools

Speed range	0 – 6000 rpm
Maximum torque	4 Nm
Maximum drive power	1,2 kW
Number of driven tools	6

Feed drives

Rapid motion speed X / Y / Z	20 / 10 / 30 m/min
Feed force in the X / Y / Z axis	3000 / 4000 / 4000 N
Positioning scatter VDI 3441 in X / Y / Z	3,5 / 3 / 3,5 µm

Coolant system

Tank volume	140 Liter
Pump power standard	0,57 (2,2) kW
Pump capacity at 3,5bar / 1bar	15 / 65 l/min
Pump capacity at 14 bar / 6 bar (optional)	10 / 60 l/min

Power consumption

Connected load	12 kVA
Compressed air	6 bar

Dimensions and weight

Height of spindle center above floor	1140 mm
Total machine height	1870 mm
Foot print (without chip conveyor) LxD	2180 x 1425 mm
Total weight	2100 kg

Safety devices CE conform

beyond standard /

EMCO GmbH / Salzburger Str. 80 / 5400 Hallein-Taxach / Austria / T +43 6245891-0 / F +43 624586965 / info@emco.at

www.emco-world.com